

Acer

**Aspire X3910
Service Guide**

Service guide files and updates are available on the ACER/CSD web; for more information, please refer to <http://csd.acer.com.tw>

PRINTED IN TAIWAN

Revision History

Please refer to the table below for the updates made on this service guide.

Date	Chapter	Updates

Copyright

Copyright © 2010 by Acer Incorporated. All rights reserved. No part of this publication may be reproduced, transmitted, transcribed, stored in a retrieval system, or translated into any language or computer language, in any form or by any means, electronic, mechanical, magnetic, optical, chemical, manual or otherwise, without the prior written permission of Acer Incorporated.

Disclaimer

The information in this guide is subject to change without notice.

Acer Incorporated makes no representations or warranties, either expressed or implied, with respect to the contents hereof and specifically disclaims any warranties of merchantability or fitness for any particular purpose. Any Acer Incorporated software described in this manual is sold or licensed "as is". Should the programs prove defective following their purchase, the buyer (and not Acer Incorporated, its distributor, or its dealer) assumes the entire cost of all necessary servicing, repair, and any incidental or consequential damages resulting from any defect in the software.

Acer is a registered trademark of Acer Corporation.

Intel is a registered trademark of Intel Corporation.

Pentium Dual-Core, Celeron Dual-Core, Core 2 Duo, Core 2 Quad, Celeron, and combinations thereof, are trademarks of Intel Corporation.

Other brand and product names are trademarks and/or registered trademarks of their respective holders.

Conventions

The following conventions are used in this manual:

SCREEN MESSAGES	Denotes actual messages that appear on screen.
NOTE	Gives additional information related to the current topic.
WARNING	Alerts you to any physical risk or system damage that might result from doing or not doing specific actions.
CAUTION	Gives precautionary measures to avoid possible hardware or software problems.
IMPORTANT	Reminds you to do specific actions relevant to the accomplishment of procedures.

Service Guide Coverage

This Service Guide provides you with all technical information relating to the BASIC CONFIGURATION decided for Acer's "global" product offering. To better fit local market requirements and enhance product competitiveness, your regional office MAY have decided to extend the functionality of a machine (e.g. add-on card, modem, or extra memory capability). These LOCALIZED FEATURES will NOT be covered in this generic service guide. In such cases, please contact your regional offices or the responsible personnel/channel to provide you with further technical details.

FRU Information

Please note WHEN ORDERING FRU PARTS, that you should check the most up-to-date information available on your regional web or channel. If, for whatever reason, a part number change is made, it will not be noted in the printed Service Guide. For ACER-AUTHORIZED SERVICE PROVIDERS, your Acer office may have a DIFFERENT part number code to those given in the FRU list of this printed Service Guide. You MUST use the list provided by your regional Acer office to order FRU parts for repair and service of customer machines.

Table of Contents

Chapter 1	System Tour	1
	Features	1
	System Components	4
	Front Panel	4
	Rear Panel	6
	Internal Components	7
	System LED Indicators	8
	CMOS Setup Utility	9
Chapter 2	System Utilities	9
	Entering CMOS setup	10
	Navigating Through the Setup Utility	10
	Setup Utility Menus	11
	BIOS Recovery	25
	Disassembly Requirements	27
Chapter 3	System Disassembly	27
	Pre-disassembly Procedure	28
	Main Unit Disassembly	29
	Removing the Side Panel	30
	Removing the Front Bezel	31
	Removing the Heat Sink Fan Assembly	32
	Removing the Processor	33
	Removing the Optical Drive	34
	Removing the Hard Disk Drive	37
	Removing the Power Supply	38
	Removing the Memory Modules	40
	Removing the TV Tuner Card	41
	Removing the VGA Card	42
	Removing the Front I/O and Card Reader Boards	43
	Removing the Mainboard	46
	Hardware Diagnostic Procedure	49
Chapter 4	System Troubleshooting	49
	System Check Procedures	50
	Power System Check	50
	System External Inspection	50
	System Internal Inspection	50
	Checkpoints	51
	Viewing BIOS checkpoints	51
	Bootblock Initialization Code Checkpoints	51
	Bootblock Recovery Code Checkpoints	52
	POST Code Checkpoints	53
	DIM Code Checkpoints	55
	Beep Codes	56
	Boot Block Beep Codes	56
	POST BIOS Beep Codes	56
	Error Messages	58
	Memory	58
	Boot	58
	Storage Device	59
	Virus Related	60

Table of Contents

System Configuration	61
CMOS	62
Miscellaneous	62
USB eModule Error Messages	63
SMBIOS eModule Error Messages	63
CPU eModule Error Messages	63
MPS Table (Multi-processor) eModule Error Messages	63
Online Support Information	64
Chapter 5 System Block Diagram and Board Layout	65
System Block Diagram	65
Board Layout	66
Mainboard	66
System Jumper	68
Chapter 6 FRU (Field Replaceable Unit) List	69
X3910 Exploded Diagram	70
X3910 FRU List	72
Appendix A Technical Specifications	81

System Tour

Features

Below is a brief summary of the computer's many features:

NOTE: The features listed in this section is for your reference only. The exact configuration of the system depends on the model purchased.

Processor

- Intel Pentium Core 2 Quad Q6600/Q8200/Q8300/Q9300/Q9400/Q9550/Q9650 processor
- Intel Pentium Core 2 Duo E7400/E7500/E8500/E8600 processor
- Intel Pentium Dual-Core E2220/E5200/E5300/E5400 processor
- Intel Celeron Dual-Core E1400/E1500 processor

Chipset

- North bridge: Intel G43/G45 Express chipset
- South bridge: Intel ICH10 chipset

Memory subsystem

- Supports up to four 240-pin DDR3-1066/1333 MHz DIMM sockets
- Supports single channel or dual-channel memory mode

Media storage

- DVD-ROM SATA drive
- Combo SATA drive
- Blu-ray disc rewriter
- Super-Multi SATA DVD drive
- 160/320/640 GB or 1 TB SATA hard disk drive

Serial ATA controller

- Embedded SATA controllers
- Two SATA ports
- eSATA port

Audio

- Realtek ALC888S 8-channel audio CODEC

Networking

- Intel WG82567V Gigabit NIC
- One Gigabit Ethernet LAN port (RJ-45)

Clock Generator

- Realtek RTM875T-505

PCI I/O

- One PCI Express x16 bus slot
- One PCI Express x1 bus slot

I/O ports

- Front
 - Five USB 2.0 ports
 - Memory Stick
 - Memory Stick PRO
 - Secure Digital (SD) Card
 - miniSD Card
 - CF/II (CompactFlash Type I/II) slot
 - Headphone/speaker-out/line-out jack
 - Microphone-in jack
- Rear
 - PS/2 keyboard port
 - PS/2 mouse port
 - Microphone jack
 - Headphone/analog speakers jack or front speakers jack
 - Center speaker/subwoofer jack
 - Surround L/R speaker jack
 - Audio inside speaker jack or side speaker jack
 - S/PDIF port
 - HDMI port
 - eSATA port
 - Four USB 2.0 ports
 - Gigabit LAN port
 - VGA/monitor port

Operating system and software

- Operating system options:
 - Genuine Windows Vista® Ultimate (32/64-bit)
 - Genuine Windows Vista Home Premium (32/64-bit)
 - Windows 7
- Applications
 - Acer Empowering Technology (Acer eRecovery Management)
 - Acer Arcade Live
 - McAfee Internet Security Suite 2009 Trial version
 - Nero 9

System BIOS

- SPI Flash ROM 16 MB

Power supply

- 220-watts (115/230 Vac) power supply

Dimension and weight





- Dimension (DxWxH)
 - X3300: 265 x 100 x 362 mm (with bezel)
 - X5300: 265 x 100 x 397 mm (with bezel)
- Weight (estimate): 5.6 kg (MVB SKU)

System Components

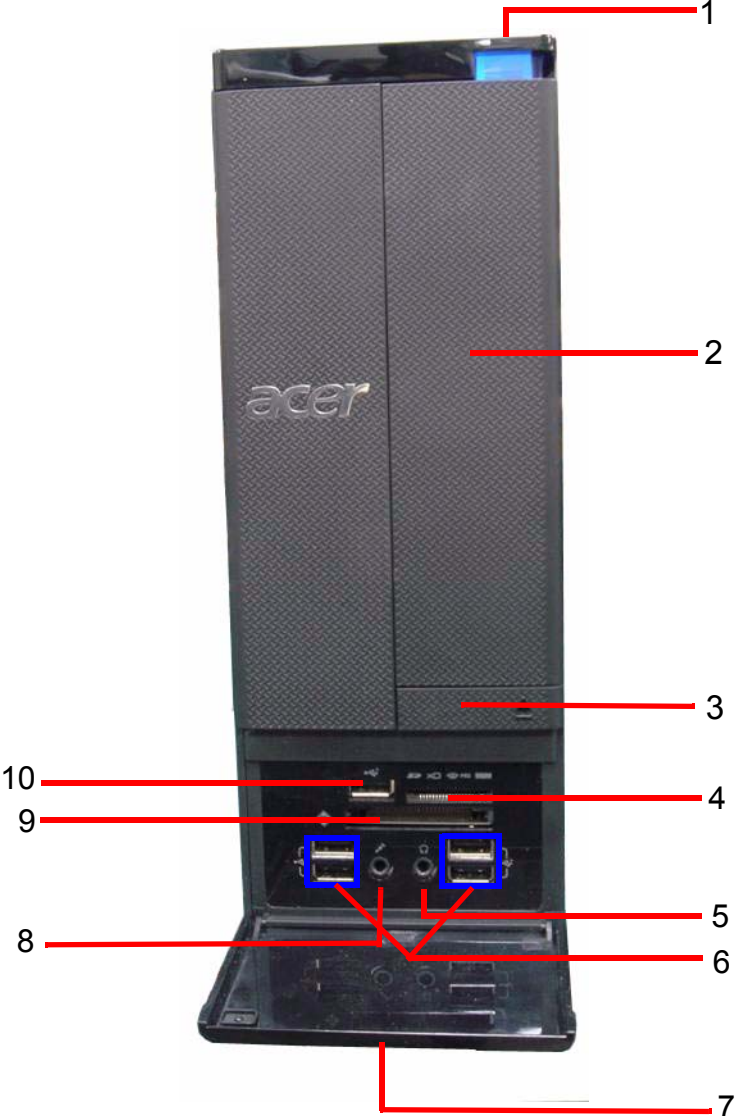
This section is a virtual tour of the system's interior and exterior components.







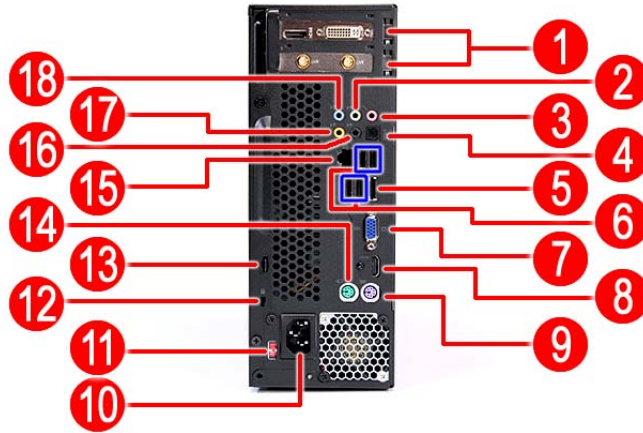

Front Panel



No.	Icon	Component
1		Power button/power indicator
2		Optical drive bay door
3		Drive bay door eject button Press to open drive bay door and access the optical drive.
4		Media card reader
5		Headphone/Speaker-out/line-out jack
6		USB 2.0 ports
7		Front IO cover
8		Microphone-in jack
9		CF I/II (CompactFlash Type I/II) slot
10		USB 2.0 port

Rear Panel



No.	Icon	Component
1		Expansion slot (Photo shows graphics card and TV tuner card)
2		Line-out jack
3		Microphone/speaker-out/line-in jack
4		S/PDIF port
5		eSATA port
6		USB 2.0 ports
7		VGA/monitor port
8		HDMI port
9		PS2 keyboard port
10		Power connector
11		Voltage selector switch
12		Lock slot
13		Key hole
14		PS2 mouse port
15		Gigabit LAN port (10/100/1000 Mbps)
16		Rear speaker/surround out jack
17		Center speaker/subwoofer jack
18		Audio in or side speaker jack

Internal Components

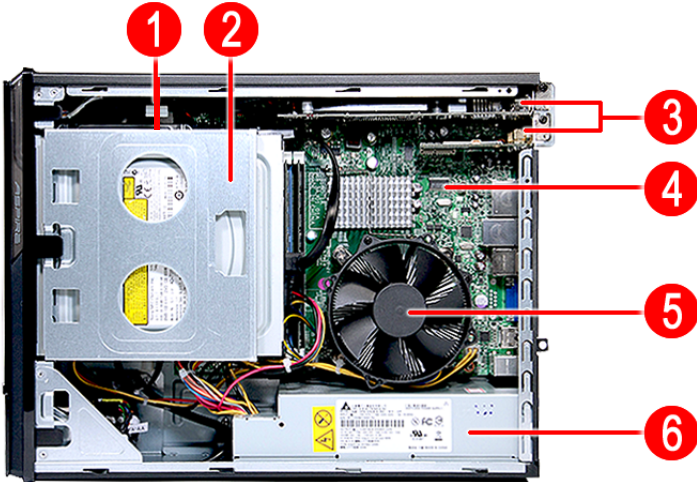

No.	Component
1	HDD drive
2	Optical drive
3	Expansion cards
4	Mainboard
5	Heat sink fan assembly
6	Power supply

System LED Indicators

This section describes the different system LED indicators.

LED indicator	Color	LED status	Description
Power	Green	On	The system has AC power and is powered on.
	Green	Blinking	The system is in standby mode.
	—	Off	System is not powered on.
HDD activity	Green	On	HDD is installed and functioning correctly.
	Green	Blinking	Ongoing HDD activity.
	Green/ Amber	Flashing	HDD is rebuilding data.
	Amber	On	HDD failure
LAN port network speed LED (left)	Amber	On	GbE link network access
	Green	On	100 Mbps link network access
	—	Off	10 Mbps link network access
LAN port network connection LED (right)	Green	On	Active network link
		Blinking	Ongoing network data activity
		Off	Off-line network

System Utilities

CMOS Setup Utility

CMOS setup is a hardware configuration program built into the system ROM, called the complementary metal-oxide semiconductor (CMOS) Setup Utility. Since most systems are already properly configured and optimized, there is no need to run this utility. You will need to run this utility under the following conditions.

- When changing the system configuration settings
- When redefining the communication ports to prevent any conflicts
- When modifying the power management configuration
- When changing the password or making other changes to the security setup
- When a configuration error is detected by the system and you are prompted ("Run Setup" message) to make changes to the CMOS setup

NOTE: If you repeatedly receive Run Setup messages, the battery may be bad. In this case, the system cannot retain configuration values in CMOS. Ask a qualified technician for assistance.

CMOS setup loads the configuration values in a battery-backed nonvolatile memory called CMOS RAM. This memory area is not part of the system RAM which allows configuration data to be retained when power is turned off.

Before you run the *CMOS Setup Utility*, make sure that you have saved all open files. The system reboots immediately after you close the Setup.

NOTE: *CMOS Setup Utility* will be simply referred to as "BIOS", "Setup", or "Setup utility" in this guide.

The screenshots used in this guide display default system values. These values may not be the same those found in your system.

Entering CMOS setup

1. Turn on the computer and the monitor.

If the computer is already turned on, close all open applications, then restart the computer.

2. During POST, press **Delete**.

If you fail to press **Delete** before POST is completed, you will need to restart the computer.

The Setup Main menu will be displayed showing the Setup's menu bar. Use the left and right arrow keys to move between selections on the menu bar.

Navigating Through the Setup Utility

Use the following keys to move around the Setup utility.

- **Left** and **Right** arrow keys – Move between selections on the menu bar.
- **Up** and **Down** arrow keys – Move the cursor to the field you want.
- **PgUp** and **PgDn** keys – Move the cursor to the previous and next page of a multiple page menu.
- **Home** – Move the cursor to the first page of a multiple page menu.
- **End** – Move the cursor to the last page of a multiple page menu.
- **+** and **-** keys – Select a value for the currently selected field (only if it is user-configurable). Press these keys repeatedly to display each possible entry, or the **Enter** key to choose from a pop-up menu.

NOTE: Grayed-out fields are not user-configurable.

- **Enter** key – Display a submenu screen.

NOTE: Availability of submenu screen is indicated by a (>).

- **Esc** – If you press this key:
 - q On one of the primary menu screens, the Exit menu displays.
 - q On a submenu screen, the previous screen displays.
 - q When you are making selections from a pop-up menu, closes the pop-up without making a selection.
- **F1** – Display the General Help panel.
- **F9** – Press to load optimized default system values.
- **F10** – Save changes made the Setup and close the utility.

Setup Utility Menus

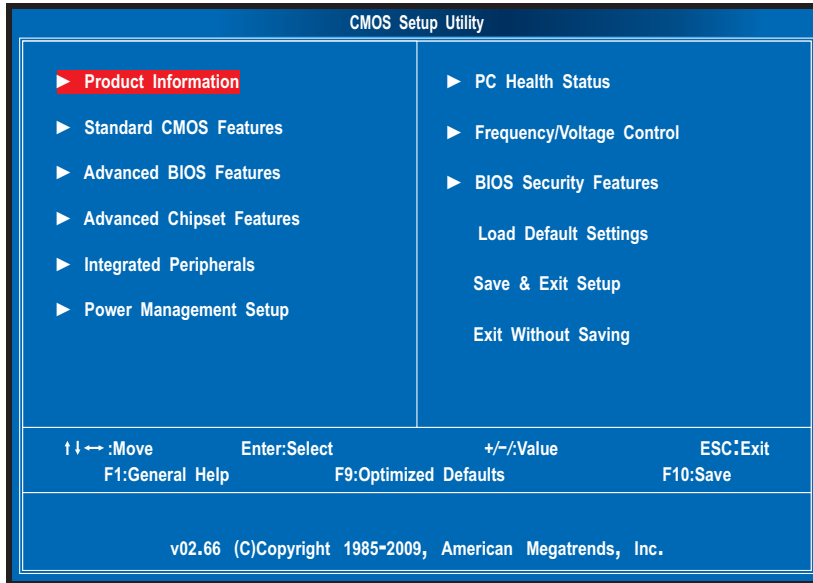

The Setup Main menu includes the following main setup categories.

- Product Information
- Standard CMOS Features
- Advanced BIOS Features
- Advanced Chipset Features
- Integrated Peripherals
- Power Management Setup
- PC Health Status
- Frequency/Voltage Control
- BIOS Security Features
- Load Default Settings
- Save & Exit Setup
- Exit Without Saving

In the descriptive table following each of the menu screenshots, settings in **boldface** are the default and suggested settings.

Product Information

The Product Information menu displays basic information about the system. These entries are for your reference only and are not user-configurable.

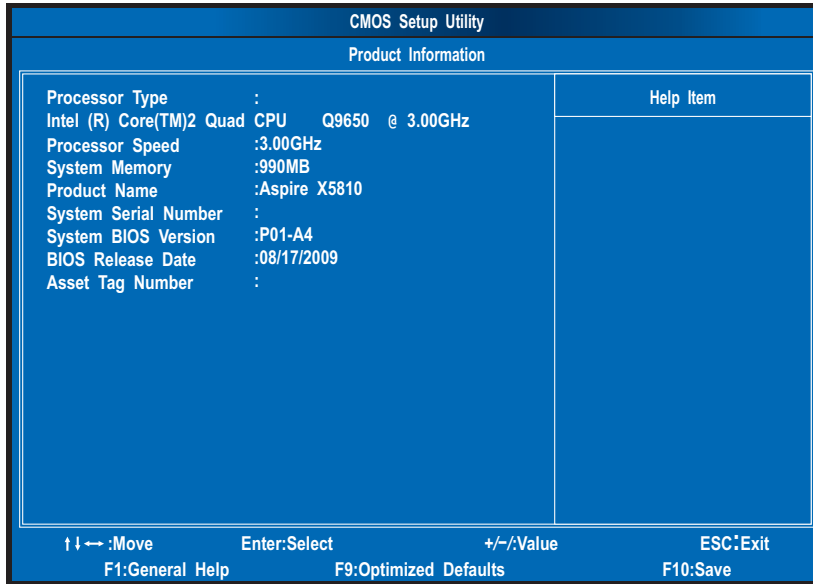

Parameter	Description
Processor Type	Type of CPU installed on the system.
Processor Speed	Speed of the CPU installed on the system.
System Memory	Total size of system memory installed on the system.
Product Name	Product name of the system.
System Serial Number	Serial number of the system.
System BIOS Version	Version number of the BIOS setup utility.
BIOS Release Date	Date when the BIOS setup utility was released
Asset Tag Number	Asset tag number of this system.

Standard CMOS Features

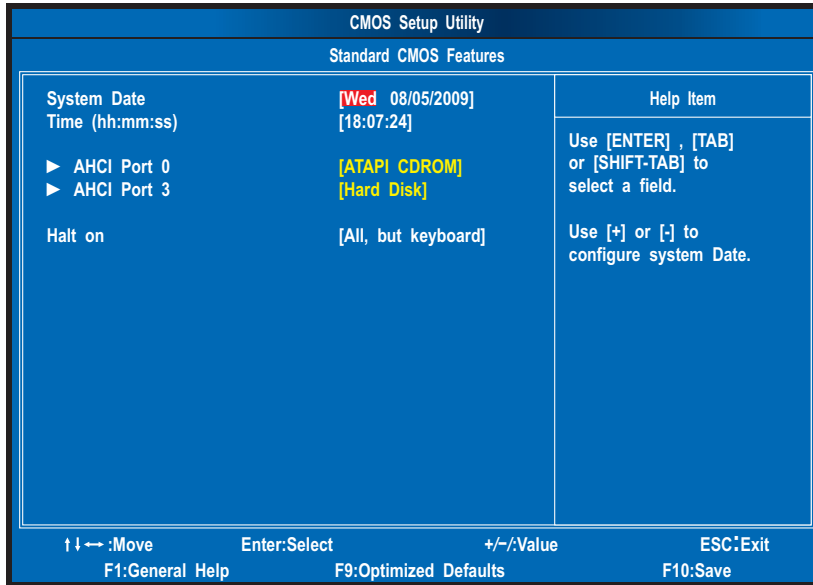

Parameter	Description	Option
System Date	Set the date following the weekday-month-day-year format.	
Time (hh:mm:ss)	Set the system time following the hour-minute-second format.	
AHCI Port 0/3	Displays the status of auto detection of the AHCI device.	
Halt on	Determines whether the system will stop for an error during the POST.	All, but keyboard No Errors All Errors

Advanced BIOS Features

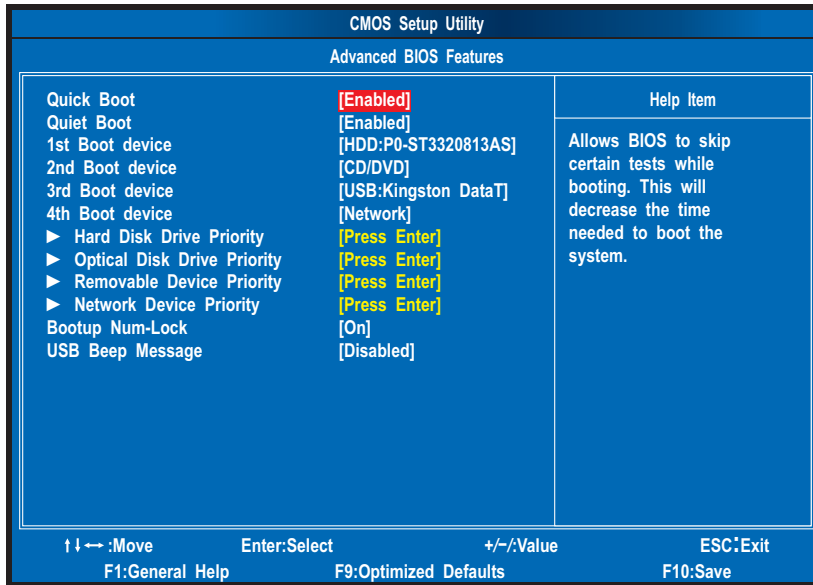

Parameter	Description	Option
Quick Boot	Allows you to decrease the time it takes to boot the computer by shortening or skipping certain standard booting process.	Enabled Disabled
Quiet Boot	When enabled, the BIOS splash screen displays during startup. When disabled, the diagnostic screen displays during startup.	Enabled Disabled
1st/2nd/3rd/4th Boot Device	Specifies the boot order from the available devices.	Hard Disk CD^DVD Removable Device LAN
Hard Disk Drive Priority	Press Enter to access the Hard Disk Drive Priority submenu and specify the boot device priority sequence from available hard drives.	
Optical Disk Drive Priority	Press Enter to access the Optical Disk Drive Priority submenu and specify the boot device priority sequence from available CD/DVD drives.	
Removable Device Priority	Press Enter to access the Removable Device Priority submenu and specify the boot device priority sequence from available removable drives.	
Network Device Priority	Press Enter to access the Network Device Priority submenu and specify the boot sequence from available network devices.	
Bootup Num-Lock	Selects power on state for Num Lock.	On Off
USB Beep Message	Enables or disables BIOS to display error beeps or messages during USB device enumeration.	Disabled Enabled

Advanced Chipset Features

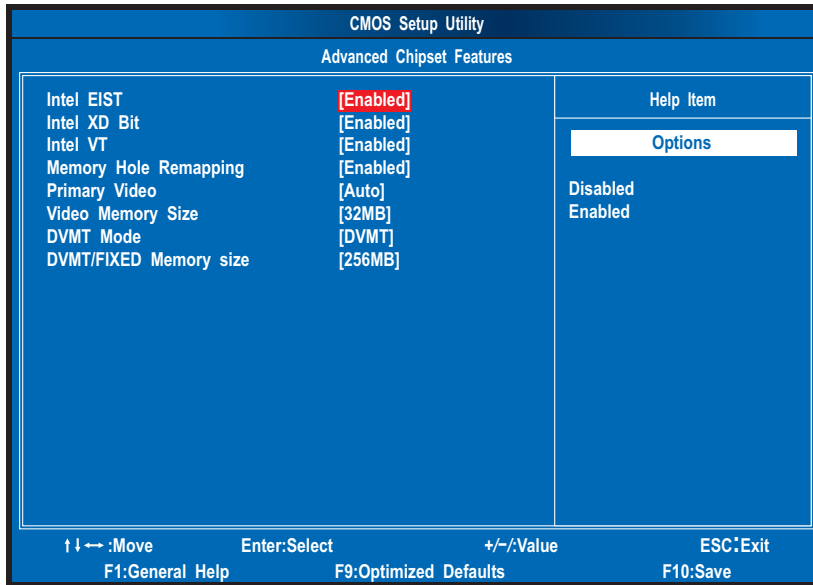

Parameter	Description	Option
Intel EIST	When enabled, this feature allows the OS to reduce power consumption. When disabled, the system operates at maximum CPU speed.	Enabled Disabled
Intel XD Bit	When enabled, the processor disables code execution when a worm attempts to insert a code in the buffer preventing damage and worm propagation. When disabled, the processor forces the Execute Disable (XD) Bit feature flag to always return to 0.	Enabled Disabled
Intel VT	Enables or disables the Virtualization Technology (VT) availability. If enabled, a virtual machine manager (VMM) can utilize the additional hardware virtualization capabilities provided by this technology. Note: A full reset is required to change the setting.	Enabled Disabled
Memory Hole Remapping	Enables or disables remapping of overlapped PCI memory above the total physical memory.	Enabled Disabled
Primary Video	Select a graphic controller as a primary boot device.	Auto PCIE Onboard VGA
Video Memory Size	Select the amount of system memory used by the Intel graphics device.	32 MB 64 MB 128 MB Disabled
DVMT Mode	Select a video memory mode.	DVMT Fixed
DVMT/FIXED Memory Size	Select a video memory size.	256 MB 128 MB Maximum

Integrated Peripherals

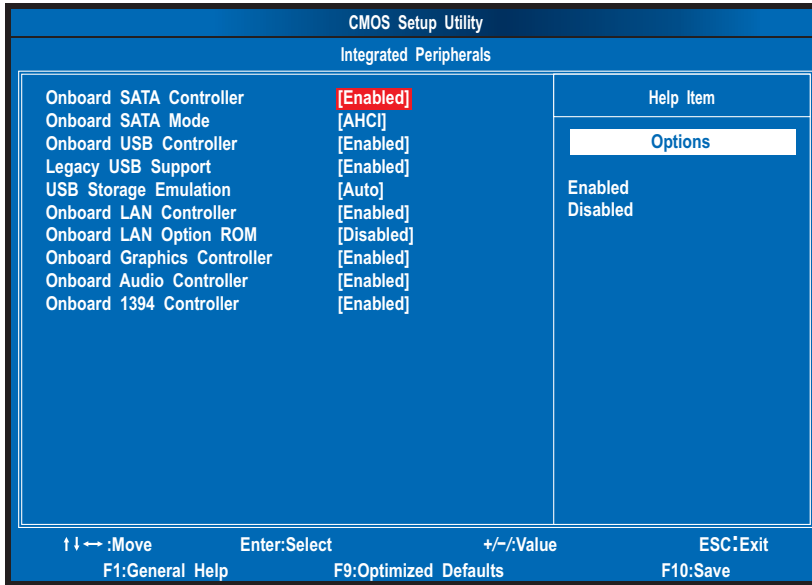

Parameter	Description	Option
Onboard SATA Controller	Select an operating mode for the onboard SATA.	Enabled Disabled
Onboard SATA Mode	Select an operating mode for the onboard SATA.	AHCI Native IDE
Onboard USB Controller	Enables or disables support for legacy USB devices	Enabled Disabled
Legacy USB Support	Enables or disables support for legacy USB devices.	Enabled Disabled
USB Storage Emulation	When set to Auto, USB devices less than 2 GB will be emulated as Floppy and remaining as HDD. Forced HDD option can be used to force a HDD formatted drive to boot as FDD.	Auto Floppy Hard Disk
Onboard LAN Controller	Enables or disables the onboard LAN controller.	Enabled Disabled
Onboard LAN Option ROM	Enables or disables the load of embedded option ROM for onboard network controller.	Disabled Enabled
Onboard Audio Controller	Enables or disables the onboard audio controller.	Enabled Disabled
Onboard 1394 Controller	Enables or disables the onboard 1394 controller.	Enabled Disabled

Power Management Setup

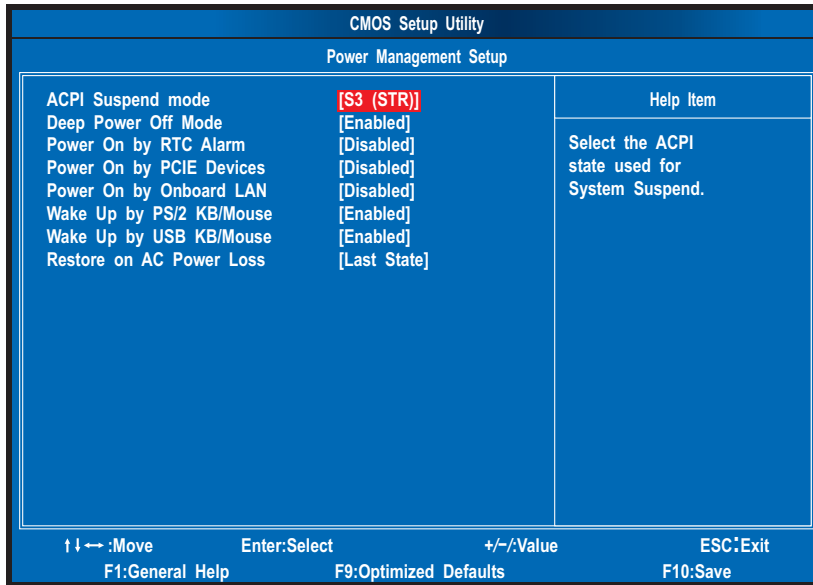

Parameter	Description	Option
ACPI Suspend Mode	Select an ACPI state.	S3 (STR) S1 (POS)
Deep Power Off Mode	Enables or disables the deep power off mode.	Enabled Disabled
Power On by RTC Alarm	Enables or disables real time clock (RTC) to generate a wake event.	Disabled Enabled
Power On by PCIE Devices	Enables or disables to wake up the system from a power saving mode through an event on PCI Express device.	Enabled Disabled
Power On by Onboard LAN	Enables or disables an onboard LAN controller to generate a wake event.	Disabled Enabled
Wake Up by PS/2 KB/Mouse	Enables or disables to wake up the system from a power saving mode using a PS2 keyboard or mouse.	Enabled Disabled
Wake Up by USB KB/Mouse	Enables or disables to wake up the system from a power saving mode using a USB keyboard or mouse.	Enabled Disabled
Restore On AC Power Loss	Enables or disables the system to reboot after a power failure or interrupt occurs.	Power Off Power On Last State

PC Health Status

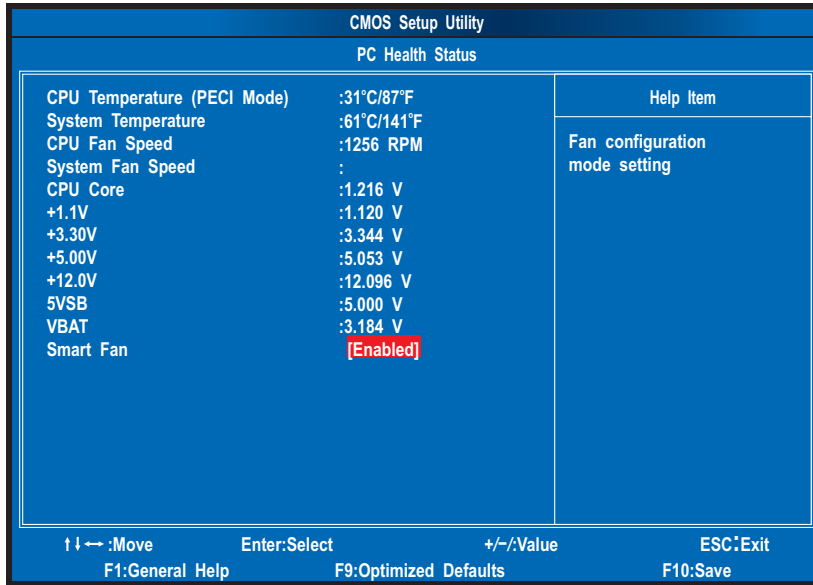

Parameter	Description	Option
Smart FAN	Enables or disables the smart system fan control function.	Enabled Disabled

Frequency/Voltage Control

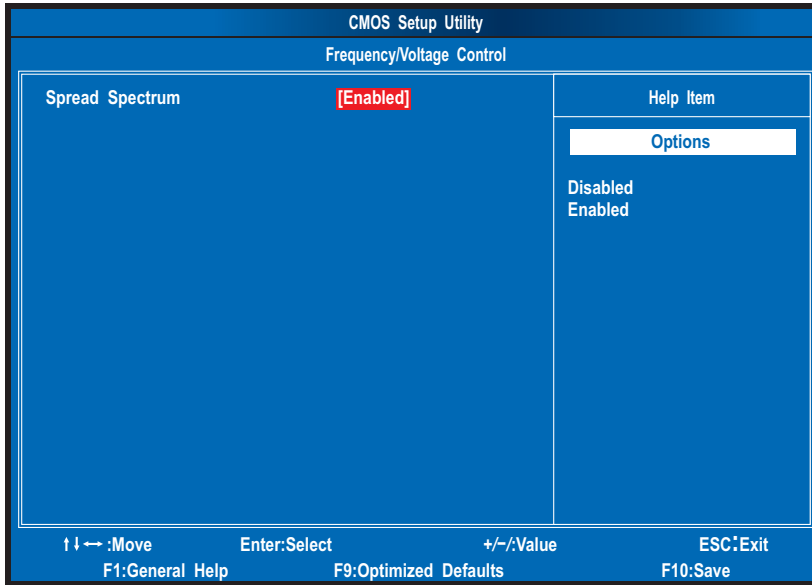

Parameter	Description	Option
Spread Spectrum	Enables or disables the reduction of the mainboard's EMI. Note: Remember to disable the Spread Spectrum feature if you are overclocking. A slight jitter can introduce a temporary boost in clock speed causing the overclocked processor to lock up.	Enabled Disabled

BIOS Security Features

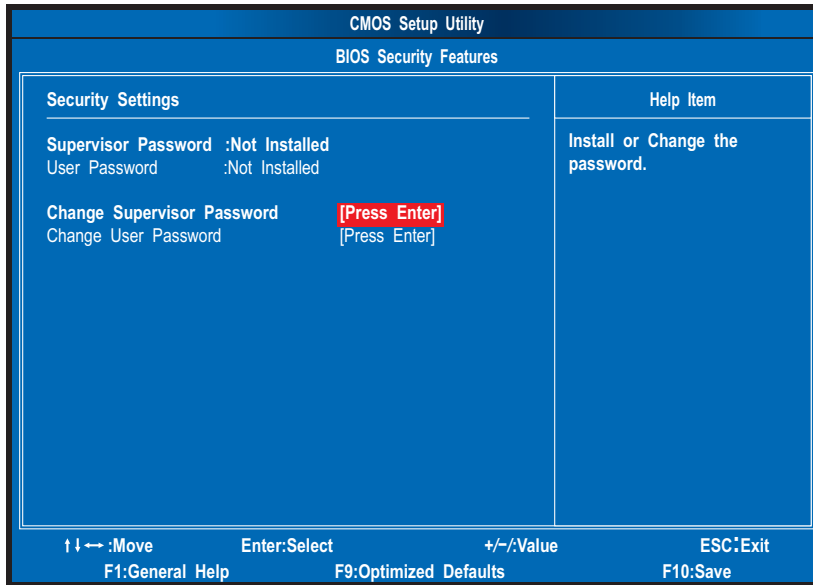

Parameter	Description
Supervisor Password	Indicates the status of the supervisor password.
User Password	Indicates the status of the user password.
Change Supervisor Password	Supervisor password prevents unauthorized access to the BIOS Setup Utility. Press Enter to change the Supervisor password.
Change User Password	Press Enter to change the User password.

Setting a system password

1. Use the up/down arrow keys to select a password parameter (Change Supervisor Password or Change User Password) menu then press **Enter**.
A password box will appear.
2. Type a password then press **Enter**.
The password may consist up to six alphanumeric characters (A-Z, a-z, 0-9)
3. Retype the password to verify the first entry then press **Enter** again.
4. Press **F10**.
5. Select **Yes** to save the new password and close the Setup Utility.

Changing the system password

1. Use the up/down arrow keys to select password parameter (Change Supervisor Password or Change User Password) menu then press **Enter**.
2. Type the original password then press **Enter**.
3. Type a new password then press **Enter**.
4. Retype the password to verify the first entry then press **Enter** again.
5. Press **F10**.
6. Select **Yes** to save the new password and close the Setup Utility.

Removing a system password

1. Use the up/down arrow keys to select password parameter (Change Supervisor Password or Change User Password) menu then press **Enter**.
2. Enter the current password then press **Enter**.
3. Press **Enter** twice without entering anything in the password fields.

Load Default Settings

The Load Default Settings menu allows you to load the default settings for all BIOS setup parameters. Setup defaults are quite demanding in terms of resources consumption. If you are using low-speed memory chips or other kinds of low-performance components and you choose to load these settings, the system might not function properly.

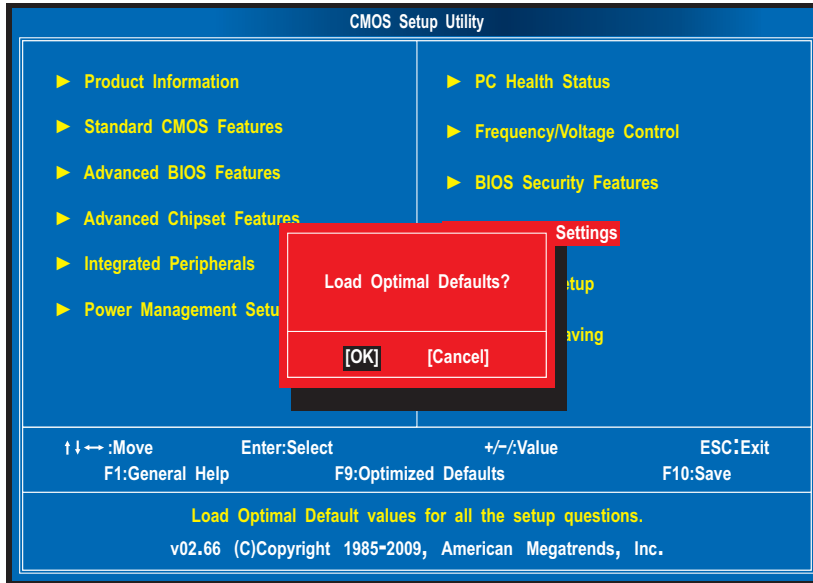

Save & Exit Setup

The Save & Exit Setup menu allows you to save changes made and close the Setup Utility.

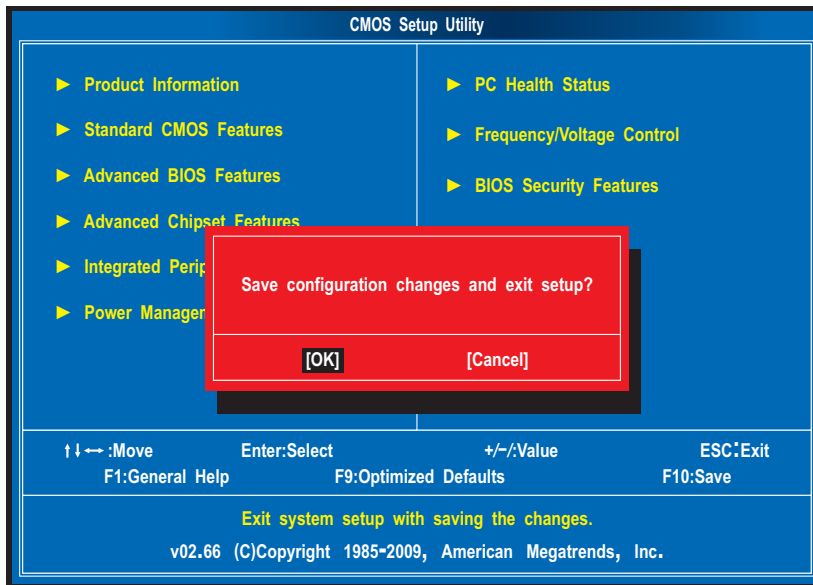

Exit Without Saving

The Exit Without Saving menu allows you to discard changes made and close the Setup Utility.

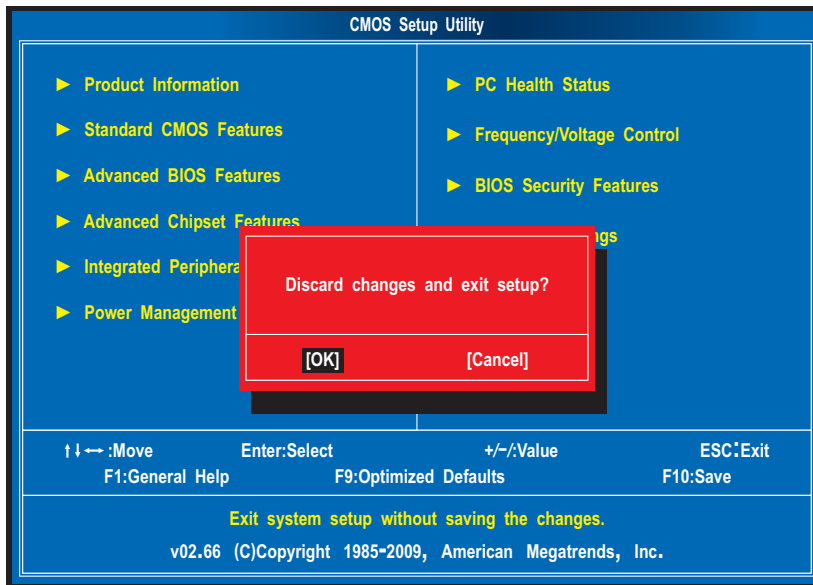

BIOS Recovery

AMIBIOS8 supports a "recovery flash" mode, which can be used to flash update a BIOS from the boot block. This is used to update a BIOS image without the need to boot to an operating system. The following is the process that user should follow to flash BIOS ROM.

1. Prepare a Disk on Key (DOK) and keep it ready in hand.
 - (1). Connect the USB storage device to a USB port on your computer.
 - (2). Save the AMIBoot.ROM to the USB storage device.
 - (3). After saving the file, unplug the USB storage device.
2. Connect the USB storage device containing the DOK to a USB port on the system.
3. Press the power button to boot the system, then press **Ctrl + Home**.

The system initializes the BIOS recovery process. The failed BIOS code will be restored from the DOK.
4. Once the process is completed, the system will restart.

System Disassembly

This chapter contains step-by-step procedures on how to disassemble the desktop computer for maintenance and troubleshooting.

Disassembly Requirements

To disassemble the computer, you need the following tools:

- Wrist grounding strap and conductive mat for preventing electrostatic discharge
- Flat-blade screwdriver
- Philips screwdriver
- Hex screwdriver
- Plastic flat-blade screwdriver
- Plastic tweezers

NOTE: The screws for the different components vary in size. During the disassembly process, group the screws with the corresponding components to avoid mismatch when putting back the components.

NOTE: The disassembling instruction below is based on an X3810 sample. You will see a slightly difference between an actual X3910 system and some images hereafter.

Pre-disassembly Procedure

Before proceeding with the disassembly procedure, perform the steps listed below:

1. Turn off the system and all the peripherals connected to it.
2. Unplug the power cord from the power outlets.
3. Unplug the power cord from the system.
4. Unplug all peripheral cables from the system.
5. Place the system unit on a flat, stable surface.

Main Unit Disassembly

MAIN UNIT DISASSEMBLY

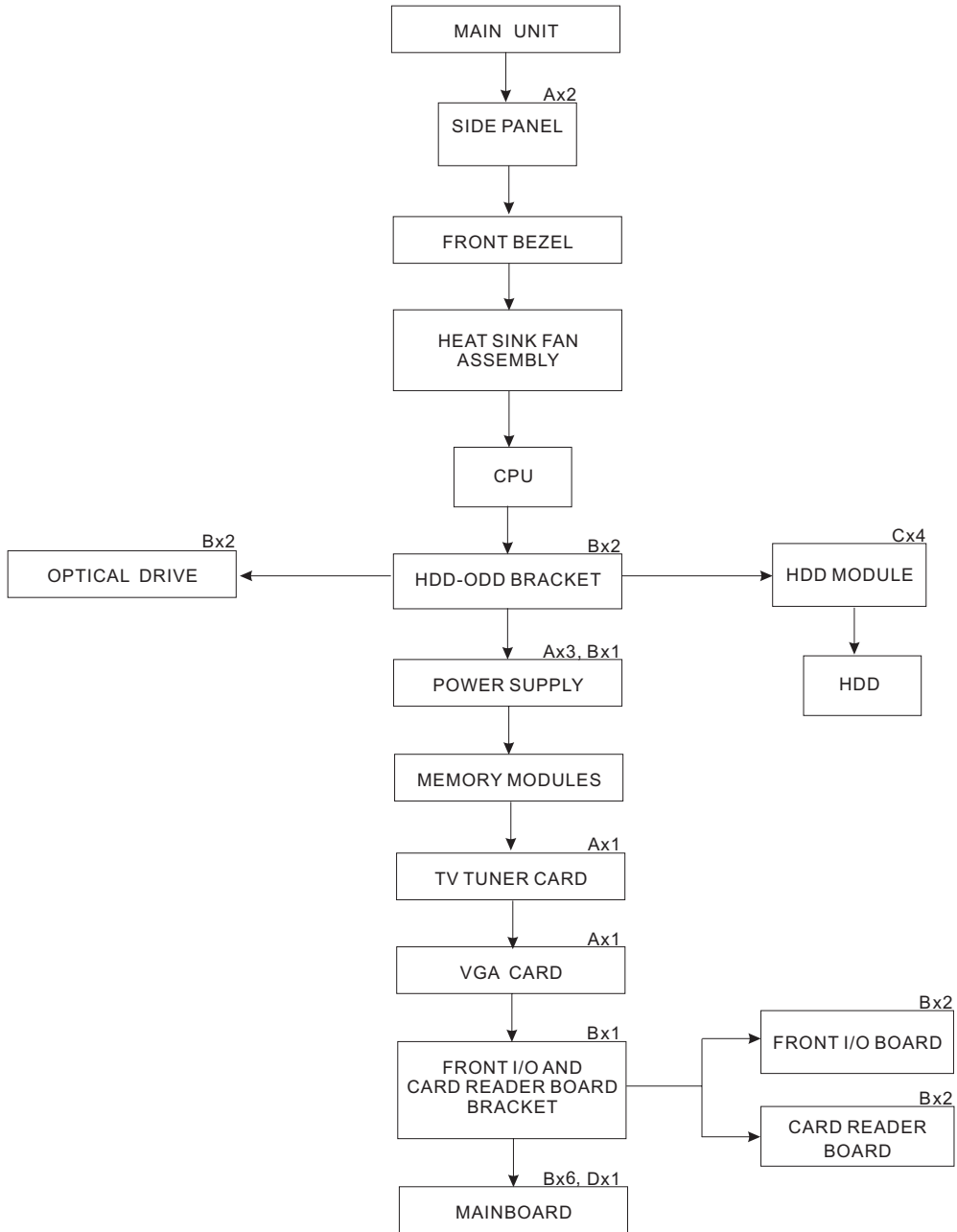

Screw List

	Screw	Part No.
A	#6-32 L5 BZN	86.00J07.B60
B	#6-32 L6 NI	86.00J44.C60
C	#6-32*3/16 NI	86.1A324.5R0
D	M3xL5 BZN	86.5A5B6.012

Removing the Side Panel

- 1. Perform the pre-disassembly procedure described on page 28.
- 2. Remove the two screws (A) located on the rear edge of the side panel.



Screw (Quantity)	Color	Torque	Part No.
#6-32 L5 BZN (2)	Black	5.7 to 6.3 kgf-cm	86.00J07.B60

- 3. Slide the side panel toward the back of the chassis until the tabs on the cover disengage with the slots on the chassis.
- 4. Lift the side panel away from the system and put it aside for reinstallation later.



Removing the Front Bezel

1. Remove the side panel. Refer to the previous section for instructions.
2. Remove the front bezel.
 - (1). Release the front bezel retention tabs from the chassis interior.
 - (2). Detach the bezel slightly away from the chassis.
 - (3). Disconnect the LED cable from the bezel and remove the bezel.
For X5810 model, skip this step.

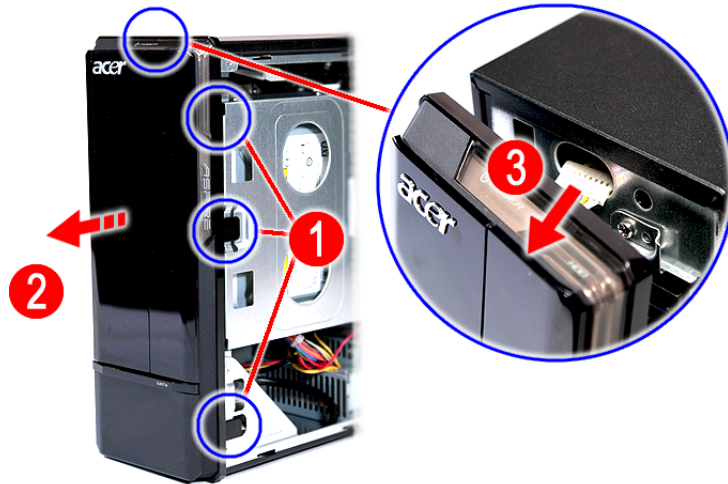

X3810

NOTE: Though these steps are applied to X3810, you can also follow the same instruction to detach X3910's front cover.

Removing the Heat Sink Fan Assembly

WARNING: The heat sink becomes very hot when the system is on. NEVER touch the heat sink with any metal or with your hands.

1. See “Removing the Side Panel” on page 30.
2. See “Removing the Front Bezel” on page 31.
3. Use a long-nosed screwdriver to loosen the four screws on the heat sink, then lift the heat sink fan assembly away from the mainboard.

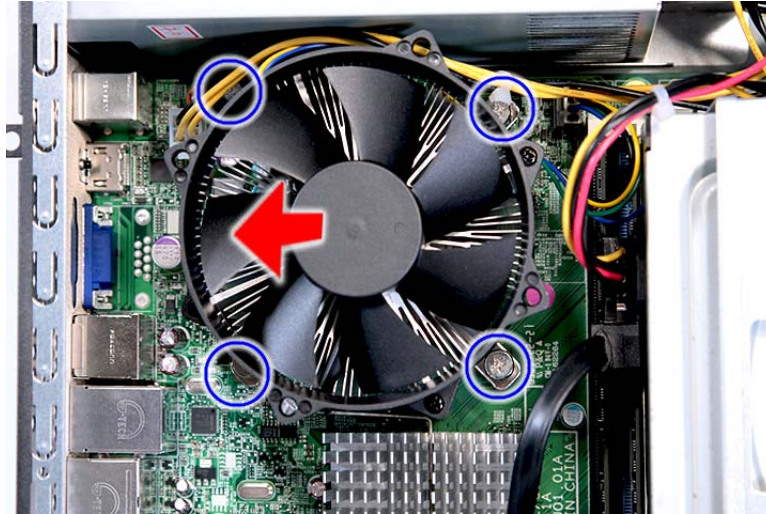

4. Lay down the heat sink fan assembly, in an upright position, on top of the optical drive, as shown below, then disconnect the fan cable from the mainboard.

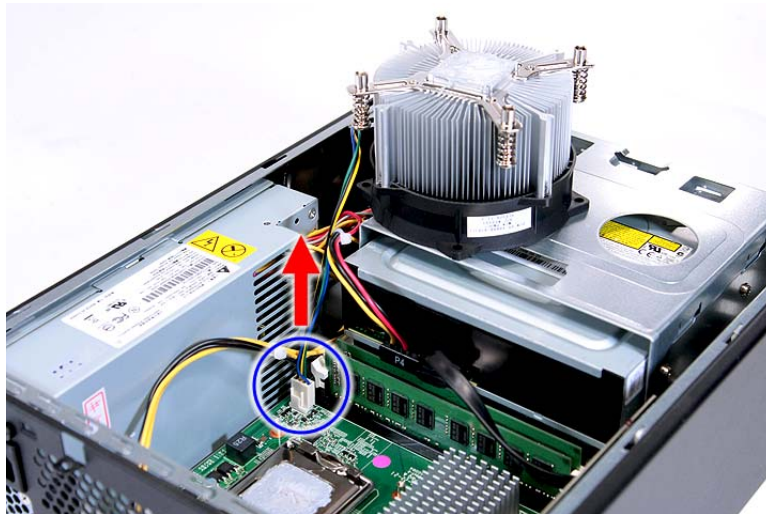

5. Remove the heat sink fan assembly from the chassis then lay it down in an upright position—with the thermal patch facing upward. Do not let the thermal patch on the heat sink fan assembly touch the work surface.
6. Use an alcohol pad to wipe off the thermal grease from both the heat sink and the processor.

Removing the Processor

IMPORTANT: Before removing a processor from the mainboard, make sure to create a backup file of all important data.

WARNING: The processor becomes very hot when the system is on. Allow it to cool off first before handling.

1. See “Removing the Side Panel” on page 30.
2. See “Removing the Heat Sink Fan Assembly” on page 32.
3. Remove the processor.
 - (1). Release the load lever and pull the load lever to the fully open, upright position.
 - (2). Open the load plate.
 - (3). Pull out the processor from the socket.

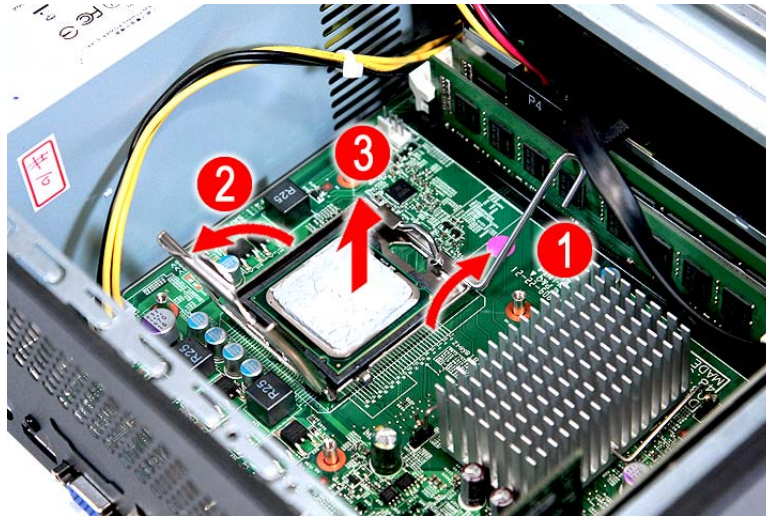

IMPORTANT: If you are going to install a new processor, note the arrow on the corner to make sure the processor is properly oriented over the socket.

Removing the Optical Drive

- 1. See “Removing the Side Panel” on page 30.
- 2. See “Removing the Front Bezel” on page 31.
- 3. See “Removing the Heat Sink Fan Assembly” on page 32.
- 4. See “Removing the Processor” on page 33.
- 5. Remove the HDD-ODD bracket.
 - (1). Disconnect the data and power cables from the optical drive.

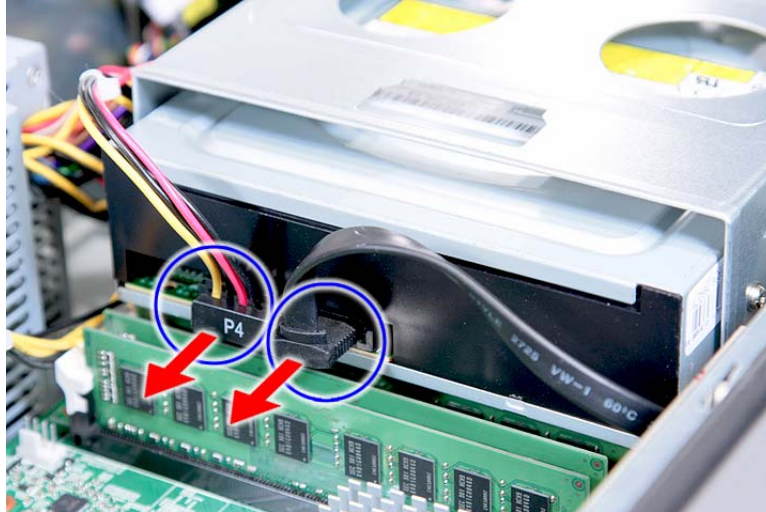

- (2). Remove the two screws (B) from the HDD-ODD bracket.



X3910

Screw (Quantity)	Color	Torque	Part No.
6-32 xL6 (2)	Silver	5.7 to 6.3 kgf-cm	86.00J44.C60

(3). Lift the HDD-ODD bracket and turn it over.



(4). Disconnect the data and power cables from the HDD.

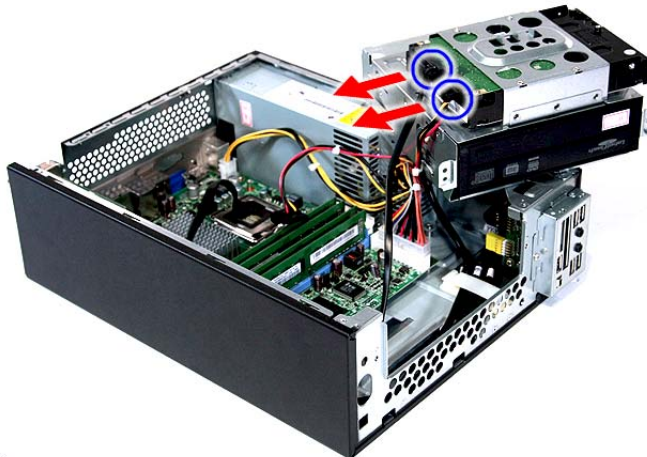

(5). Remove the HDD-ODD bracket.

6. Place the bracket on a clean, static-free work surface.

7. Remove the two screws (C) from the optical drive.



Screw (Quantity)	Color	Torque	Part No.
#6-32*3/16 NI (2)	Silver	5.5 to 6.5 kgf-cm	86.1A324.5R0

8. Slide the optical drive out of the drive bay.



Removing the Hard Disk Drive

1. See “Removing the Side Panel” on page 30.
2. See “Removing the Front Bezel” on page 31.
3. See “Removing the Heat Sink Fan Assembly” on page 32.
4. See “Removing the Processor” on page 33.
5. Remove the HDD-ODD bracket. See “Removing the Optical Drive” on page 34.
 - (1). Place the bracket on a clean, static-free work surface.
 - (2). Remove the four screws (C) that secure the HDD module to the HDD-ODD bracket.

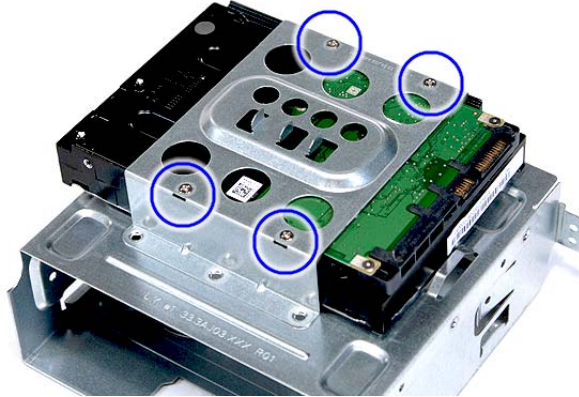

Screw (Quantity)	Color	Torque	Part No.
#6-32*3/16 NI (4)	Silver	5.7 to 6.3 kgf-cm	86.5A5B6.012

- (3). Slide the HDD out of the bracket.

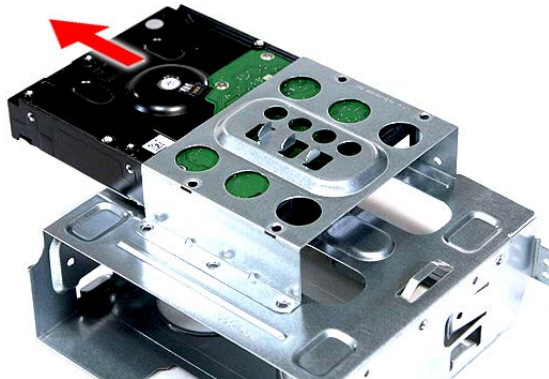

Removing the Power Supply

1. See “Removing the Side Panel” on page 30.
2. See “Removing the Heat Sink Fan Assembly” on page 32.
3. See “Removing the Processor” on page 33.
4. See “Removing the Optical Drive” on page 34.
5. Disconnect the 4-pin and 24-pin power supply cables from the mainboard.

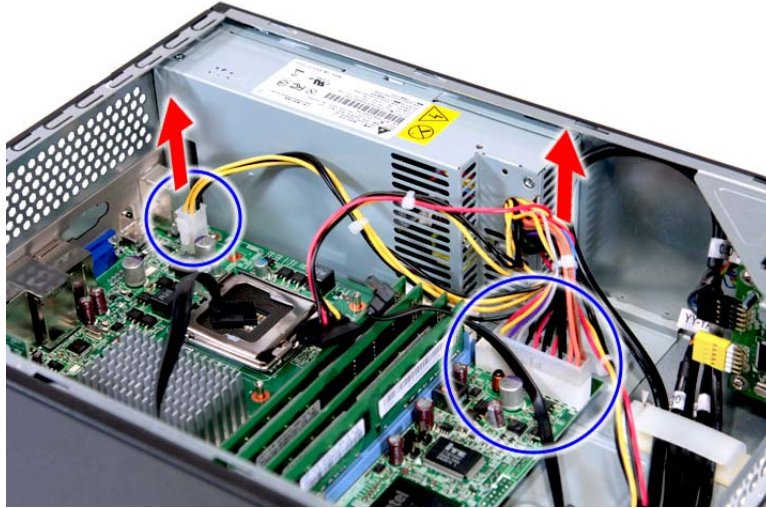

6. Remove the screw (B) that secures the power supply to the chassis.



Screw (Quantity)	Color	Torque	Part No.
#6-32 L6 (1)	Silver	5.7 to 6.3 kgf-cm	86.00J44.C60

7. Remove the three screws (A) that secure the power supply to the rear panel.



Screw (Quantity)	Color	Torque	Part No.
#6-32 L5 BZN (3)	Black	5.5 to 6.5 kgf-cm	86.00J07.B60

8. Lift the power supply module out of the chassis.

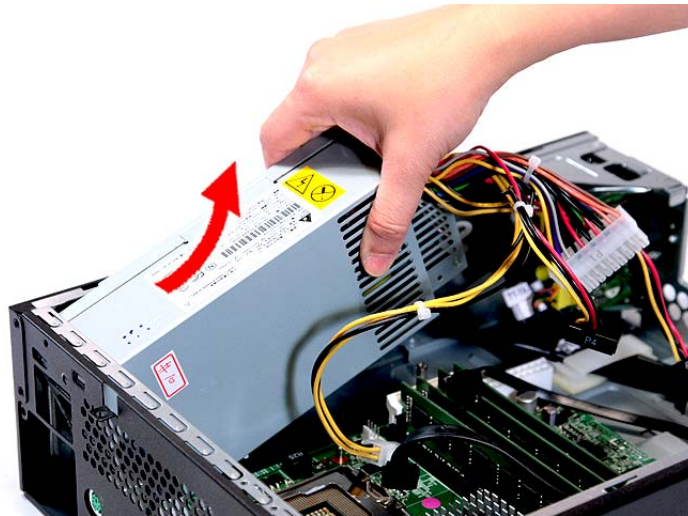

Removing the Memory Modules

IMPORTANT: Before removing any DIMM from the memory board, make sure to create a backup file of all important data.

1. See “Removing the Side Panel” on page 30.
2. See “Removing the Front Bezel” on page 31.
3. See “Removing the Heat Sink Fan Assembly” on page 32.
4. See “Removing the Processor” on page 33.
5. See “Removing the Optical Drive” on page 34.
6. Remove the memory modules
 - (1). Press the holding clips on both sides of the DIMM slot outward to release the DIMM.
 - (2). Gently pull the DIMM upward to pull it away from the chassis.

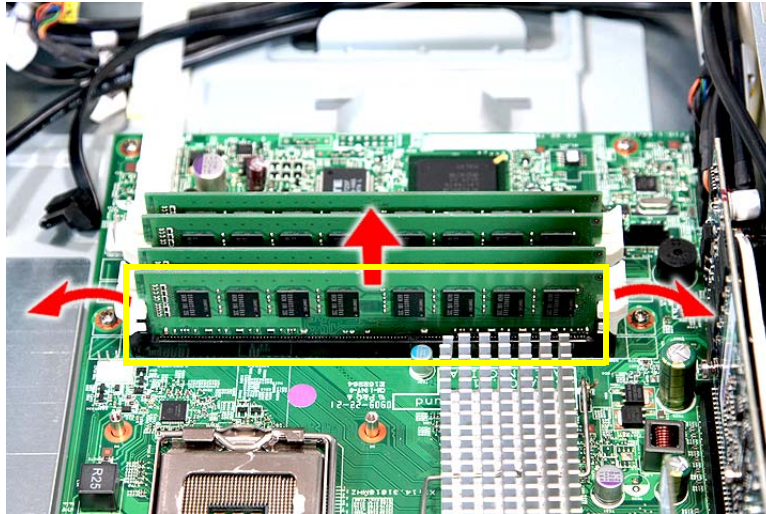

NOTE: The DIMM has been highlighted with a yellow rectangle as above image shows. Please detach the DIMM and follow local regulations for disposal.

Removing the TV Tuner Card

1. See "Removing the Side Panel" on page 30.
2. Remove the screw (A) that secures the card to the chassis.



Screw (Quantity)	Color	Torque	Part No.
#6-32 L5 BZN (1)	Black	5.5 to 6.5 kgf-cm	86.00J07.B60

3. Gently pull the card to remove it from the mainboard.

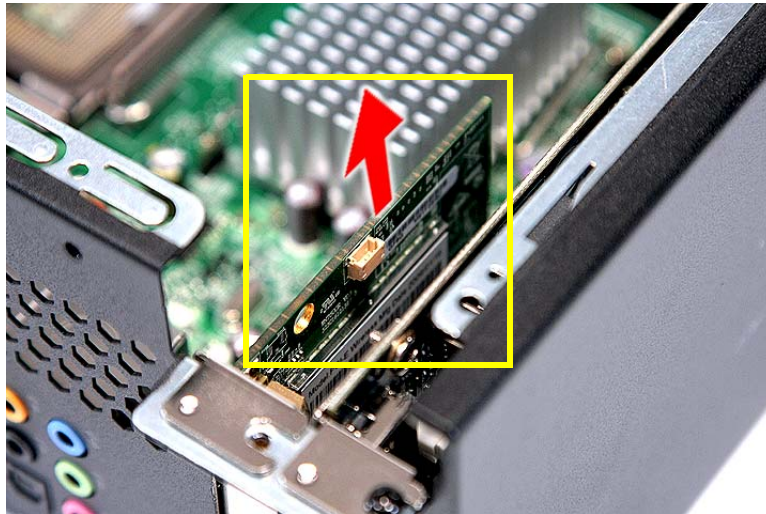

NOTE: The card has been highlighted with a yellow box as above image shows. Please detach the card and follow local regulations for disposal.

Removing the VGA Card

- 1. See "Removing the Side Panel" on page 30.
- 2. Remove the screw (A) that secures the card to the chassis.

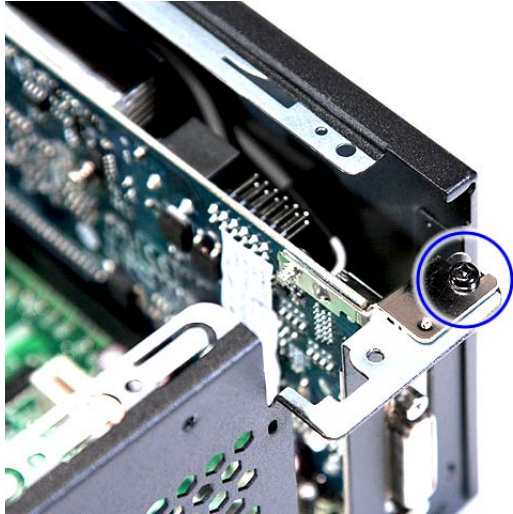

Screw (Quantity)	Color	Torque	Part No.
#6-32 L5 BZN (1)	Black	5.5 to 6.5 kgf-cm	86.00J07.B60

- 3. Gently pull the card to remove it from the mainboard.

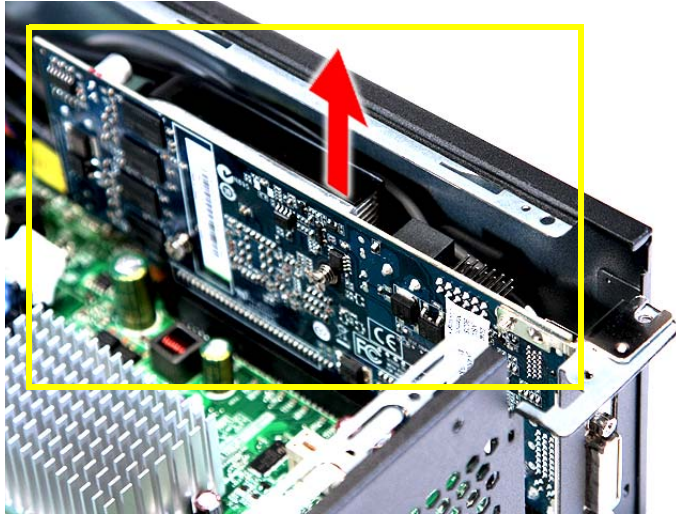

NOTE: The card has been highlighted with a yellow rectangle as above image shows. Please detach the card and follow local regulations for disposal.

Removing the Front I/O and Card Reader Boards

1. See “Removing the Side Panel” on page 30.
2. See “Removing the Front Bezel” on page 31.
3. See “Removing the Heat Sink Fan Assembly” on page 32.
4. See “Removing the Processor” on page 33.
5. See “Removing the Optical Drive” on page 34.
6. Disconnect one end of the USB, and audio cables from the I/O and card reader boards, then open the cable retention clip.

NOTE: You can see IEEE1394 cable on the image below this chapter is based on an X3810 sample. Please notice that X3910 does not have IEEE1394 port on front panel.

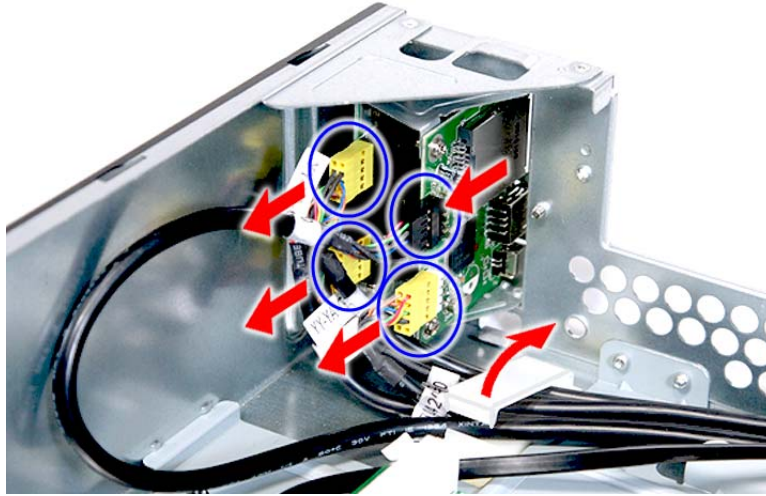

7. Open the cable retention clip and disconnect the SATA cable, LED cable, and the other end of the USB, 1394, and audio cables from the mainboard.



8. Remove the front I/O and card reader board bracket.
 - (1). Remove the screw (B) that secures the bracket to the chassis.



Screw (Quantity)	Color	Torque	Part No.
#6-32 L6 (1)	Silver	4.75 to 5.2 kgf-cm	86.00J44.C60

- (2). Remove the bracket.

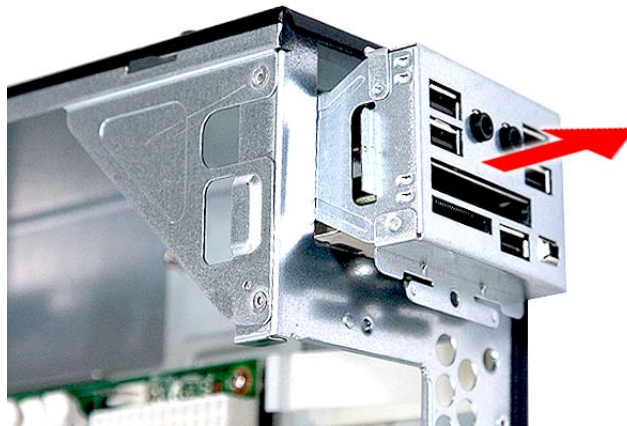

9. Remove the card reader board.
 - (1). Remove the two screws (B) that secure the card reader board to the bracket.

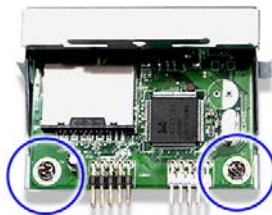

X3810



X5810

Screw (Quantity)	Color	Torque	Part No.
#6-32 L6 (2)	Silver	3.5 to 4.5 kgf-cm	86.00J44.C60

(2). Pull the card reader board out of the bracket.



X3810



NOTE: The card has been highlighted with a yellow rectangle as above image shows. Please detach the card and follow local regulations for disposal.

10. Remove the front I/O board.

(1). Remove the two screws (B) that secure the I/O board to the bracket.



X3810

Screw (Quantity)	Color	Torque	Part No.
#6-32 L6 (2)	Silver	3.8 to 4.2 kgf-cm	86.00J44.C60

(2). Pull the I/O board out of the bracket.

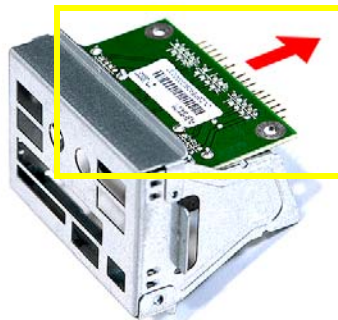

X3810



NOTE: The card has been highlighted with a yellow rectangle as above image shows. Please detach the card and follow local regulations for disposal.

Removing the Mainboard

1. See “Removing the Side Panel” on page 30.
2. See “Removing the Front Bezel” on page 31.
3. See “Removing the Heat Sink Fan Assembly” on page 32.
4. See “Removing the Processor” on page 33.
5. See “Removing the Optical Drive” on page 34.
6. See “Removing the Hard Disk Drive” on page 37.
7. See “Removing the Memory Modules” on page 40.
8. See “Removing the TV Tuner Card” on page 41.
9. See “Removing the VGA Card” on page 42.
10. See “Removing the Front I/O and Card Reader Boards” on page 43.
11. Remove the six screws (B) that secure the mainboard to the chassis.

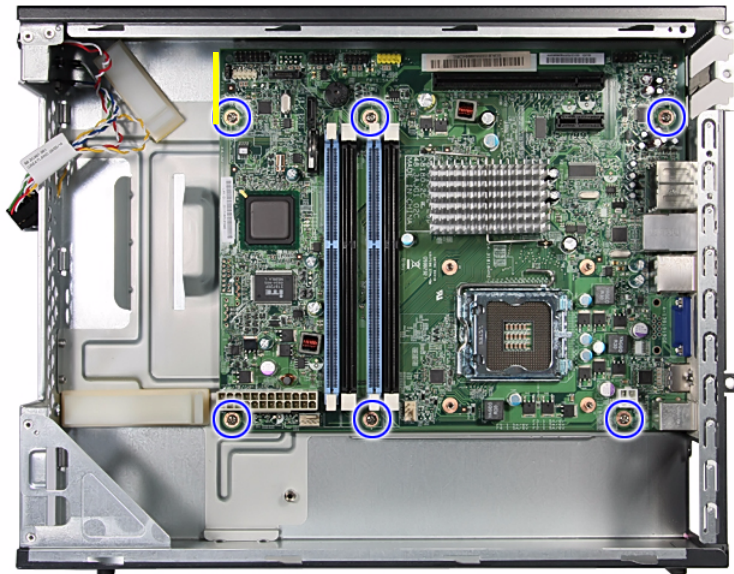

Screw (Quantity)	Color	Torque	Part No.
#6-32 L6 (6)	Silver	5.7 to 6.3 kgf-cm	86.00J44.C60

12. Remove the screw (D) on the rear panel.



Screw (Quantity)	Color	Torque	Part No.
M3xL5 BZN (1)	Black	5.5 to 6.5 kgf-cm	86.5A5B6.012

13. Lift the board from the chassis.

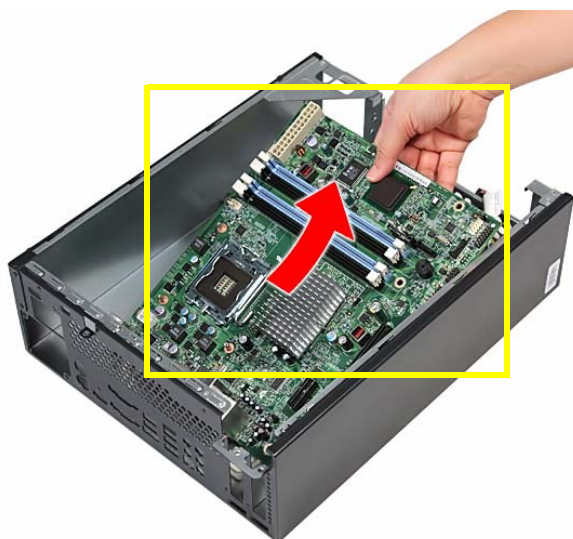

NOTE: The mainboard has been highlighted with a yellow rectangle as above image shows. Please detach the mainboard and follow local regulations for disposal.

System Troubleshooting

This chapter provides instructions on how to troubleshoot system hardware problems.

Hardware Diagnostic Procedure

IMPORTANT: The diagnostic tests described in this chapter are only intended to test Acer products. Non-Acer products, prototype cards, or modified options can give false errors and invalid system responses.

1. Obtain the failing symptoms in as much detail as possible.
2. Verify the symptoms by attempting to recreate the failure by running the diagnostic tests or repeating the same operation.
3. Refer to “Power System Check” on page 50 and “Beep Codes” on page 56 to determine which corrective action to perform.

System Check Procedures

Power System Check

If the system will power on, skip this section. Refer to System External Inspection.

If the system will not power on, do the following:

- q Check if the power cable is properly connected to the system and AC source.
- q Check if the voltage selector switch is set to the correct voltage setting.

System External Inspection

1. Inspect the LED indicators on the front panel, which can indicate the malfunction. For the LED locations and description of their behaviour, see “System LED Indicators” on page 8.
2. Make sure that air flow is not blocked.
3. Make sure nothing in the system is making contact that could short out power.
4. If the problem is not evident, continue with System Internal Inspection.

System Internal Inspection

1. Turn off the system and all the peripherals connected to it.
2. Unplug the power cord from the power outlets.
3. Unplug the power cord from the system.
4. Unplug all peripheral cables from the system.
5. Place the system unit on a flat, stable surface.
6. Remove the system covers. For instructions on removing system covers, refer to “System Disassembly” on page 27.
7. Verify that components are properly seated.
8. Verify that all cable connectors inside the system are firmly and correctly attached to their appropriate connectors.
9. Verify that all components are Acer-qualified and supported.
10. Replace the system covers.
11. Power on the system.
12. If the problem with the system is not evident, you can try viewing the POST messages and BIOS event logs during the system startup.

Checkpoints

A checkpoint is either a byte or word value output to I/O port 80h. The BIOS outputs checkpoints throughout bootblock and Power-On Self Test (POST) to indicate the task the system is currently executing. Checkpoints are very useful in aiding software developers or technicians in debugging problems that occur during the pre-boot process.

Viewing BIOS checkpoints

Viewing all checkpoints generated by the BIOS requires a checkpoint card, also referred to as a POST card or POST diagnostic card. These are ISA or PCI add-in cards that show the value of I/O port 80h on a LED display. Checkpoints may appear on the bottom right corner of the screen during POST. This display method is limited, since it only displays checkpoints that occur after the video card has been activated.

Bootblock Initialization Code Checkpoints

The Bootblock initialization code sets up the chipset, memory, and other components before system memory is available. The following table describes the type of checkpoints that may occur during the bootblock initialization portion of the BIOS.

NOTE: Please note that checkpoints may differ between different platforms based on system configuration. Checkpoints may change due to vendor requirements, system chipset or option ROMs from add-in PCI devices.

Checkpoint	Description
Before D1	Early chipset initialization is done. Early super I/O initialization is done including RTC and keyboard controller. NMI is disabled.
D0	Go to flat mode with 4GB limit and GA20 enabled. Verify the bootblock checksum.
D1	Perform keyboard controller BAT test. Check if waking up from power management suspend state. Save power-on CPUID value in scratch CMOS.
D2	Disable CACHE before memory detection. Execute full memory sizing module. Verify that flat mode is enabled.
D3	If memory sizing module not executed, start memory refresh and do memory sizing in Bootblock code. Do additional chipset initialization. Re-enable CACHE. Verify that flat mode is enabled.
D4	Test base 512KB memory. Adjust policies and cache first 8MB. Set stack.
D5	Bootblock code is copied from ROM to lower system memory and control is given to it. BIOS now executes out of RAM.
D6	Both key sequence and OEM specific method is checked to determine if BIOS recovery is forced. Main BIOS checksum is tested. If BIOS recovery is necessary, control flows to checkpoint E0. See Bootblock Recovery Code Checkpoints section for more information.
D7	Restore CPUID value back into register. The Bootblock-Runtime interface module is moved to system memory and control is given to it. Determine whether to execute serial flash.
D8	The Runtime module is uncompressed into memory. CPUID information is stored in memory.
D9	Store the Uncompressed pointer for future use in PMM. Copying Main BIOS into memory. Leaves all RAM below 1MB Read-Write including E000 and F000 shadow areas but closing SMRAM.
DA	Restore CPUID value back into register. Give control to BIOS POST (ExecutePOSTKernel). See POST Code Checkpoints section for more information.

Bootblock Recovery Code Checkpoints

The Bootblock recovery code gets control when the BIOS determines that a BIOS recovery needs to occur because the user has forced the update or the BIOS checksum is corrupt. Refer to “BIOS Recovery” on page 25 for more information about performing a BIOS recovery.

The following table describes the type of checkpoints that may occur during the Bootblock recovery portion of the BIOS.

NOTE: Checkpoints may differ between different platforms based on system configuration. Checkpoints may change due to vendor requirements, system chipset or option ROMs from add-in PCI devices.

Checkpoint	Description
E0	Initialize the floppy controller in the super I/O. Some interrupt vectors are initialized. DMA controller is initialized. 8259 interrupt controller is initialized. L1 cache is enabled.
E9	Set up floppy controller and data. Attempt to read from floppy.
EA	Enable ATAPI hardware. Attempt to read from ARMD and ATAPI CDROM.
EB	Disable ATAPI hardware. Jump back to checkpoint E9.
EF	Read error occurred on media. Jump back to checkpoint EB.
E9 or EA	Determine information about root directory of recovery media.
F0	Search for pre-defined recovery file name in root directory.
F1	Recovery file not found.
F2	Start reading FAT table and analyze FAT to find the clusters occupied by the recovery file.
F3	Start reading the recovery file cluster by cluster.
F5	Disable L1 cache.
FA	Check the validity of the recovery file configuration to the current configuration of the flash part.
FB	Make flash write enabled through chipset and OEM specific method. Detect proper flash part. Verify that the found flash part size equals the recovery file size.
F4	The recovery file size does not equal the found flash part size.
FC	Erase the flash part.
FD	Program the flash part.
FF	The flash has been updated successfully. Make flash write disabled. Disable ATAPI hardware. Restore CPUID value back into register. Give control to F000 ROM at F000:FFF0h.

POST Code Checkpoints

The POST code checkpoints are the largest set of checkpoints during the BIOS preboot process. The following table describes the type of checkpoints that may occur during the POST portion of the BIOS.

NOTE: Please note that checkpoints may differ between different platforms based on system configuration. Checkpoints may change due to vendor requirements, system chipset or option ROMs from add-in PCI devices.

Checkpoint	Description
03	Disable NMI, Parity, video for EGA, and DMA controllers. Initialize BIOS, POST, Runtime data area. Also initialize BIOS modules on POST entry and GPNV area. Initialized CMOS as mentioned in the Kernel Variable "wCMOSFlags."
04	Check CMOS diagnostic byte to determine if battery power is OK and CMOS checksum is OK. Verify CMOS checksum manually by reading storage area. If the CMOS checksum is bad, update CMOS with power-on default values and clear passwords. Initialize status register A. Initializes data variables that are based on CMOS setup questions. Initializes both the 8259 compatible PICs in the system
05	Initializes the interrupt controlling hardware (generally PIC) and interrupt vector table.
06	Do R/W test to CH-2 count reg. Initialize CH-0 as system timer. Install the POSTINT1Ch handler. Enable IRQ-0 in PIC for system timer interrupt. Traps INT1Ch vector to "POSTINT1ChHandlerBlock."
08	Initializes the CPU. The BAT test is being done on KBC. Program the keyboard controller command byte is being done after Auto detection of KB/MS using AMI KB-5.
0A	Initializes the 8042 compatible Key Board Controller.
0B	Detects the presence of PS/2 mouse.
0C	Detects the presence of Keyboard in KBC port.
0E	Testing and initialization of different Input Devices. Also, update the Kernel Variables. Traps the INT09h vector, so that the POST INT09h handler gets control for IRQ1. Uncompress all available language, BIOS logo, and Silent logo modules.
13	Early POST initialization of chipset registers.
24	Uncompress and initialize any platform specific BIOS modules. GPNV is initialized at this checkpoint.
30	Initialize System Management Interrupt.
2A	Initializes different devices through DIM. See DIM Code Checkpoints section for more information.
2C	Initializes different devices. Detects and initializes the video adapter installed in the system that have optional ROMs.
2E	Initializes all the output devices.
31	Allocate memory for ADM module and uncompress it. Give control to ADM module for initialization. Initialize language and font modules for ADM. Activate ADM module.
33	Initializes the silent boot module. Set the window for displaying text information.
37	Displaying sign-on message, CPU information, setup key message, and any OEM specific information.
38	Initializes different devices through DIM. See DIM Code Checkpoints section for more information. USB controllers are initialized at this point.
39	Initializes DMAC-1 & DMAC-2.

Checkpoint	Description
3A	Initialize RTC date/time.
3B	Test for total memory installed in the system. Also, Check for DEL or ESC keys to limit memory test. Display total memory in the system.
3C	Mid POST initialization of chipset registers.
40	Detect different devices (Parallel ports, serial ports, and coprocessor in CPU, ... etc.) successfully installed in the system and update the BDA, EBDA...etc.
50	Programming the memory hole or any kind of implementation that needs an adjustment in system RAM size if needed.
52	Updates CMOS memory size from memory found in memory test. Allocates memory for Extended BIOS Data Area from base memory. Programming the memory hole or any kind of implementation that needs an adjustment in system RAM size if needed.
60	Initializes NUM-LOCK status and programs the KBD typematic rate.
75	Initialize Int-13 and prepare for IPL detection.
78	Initializes IPL devices controlled by BIOS and option ROMs.
7C	Generate and write contents of ESCD in NVRam.
84	Log errors encountered during POST.
85	Display errors to the user and gets the user response for error.
87	Execute BIOS setup if needed / requested. Check boot password if installed.
8C	Late POST initialization of chipset registers.
8E	Program the peripheral parameters. Enable/Disable NMI as selected.
90	Late POST initialization of system management interrupt.
A0	Check boot password if installed.
A1	Clean-up work needed before booting to OS.
A2	Takes care of runtime image preparation for different BIOS modules. Fill the free area in F000h segment with 0FFh. Initializes the Microsoft IRQ Routing Table. Prepares the runtime language module. Disables the system configuration display if needed.
A4	Initialize runtime language module. Display boot option popup menu.
A7	Displays the system configuration screen if enabled. Initialize the CPU's before boot, which includes the programming of the MTRR's.
A9	Wait for user input at config display if needed.
AA	Uninstall POST INT1Ch vector and INT09h vector. Deinitializes the ADM module.
AB	Prepare BBS for Int 19 boot.
AC	End of POST initialization of chipset registers.
B1	Save system context for ACPI.
00	Passes control to OS Loader (typically INT19h).

DIM Code Checkpoints

The Device Initialization Manager (DIM) gets control at various times during BIOS POST to initialize different system busses. The following table describes the main checkpoints where the DIM module is accessed.

NOTE: Checkpoints may differ between different platforms based on system configuration. Checkpoints may change due to vendor requirements, system chipset or option ROMs from add-in PCI devices.

Checkpoint	Description
2A	Initialize different buses and perform the following functions: Reset, Detect, and Disable (function 0); Static Device Initialization (function 1); Boot Output Device Initialization (function 2). Function 0 disables all device nodes, PCI devices, and PnP ISA cards. It also assigns PCI bus numbers. Function 1 initializes all static devices that include manual configured onboard peripherals, memory and I/O decode windows in PCI-PCI bridges, and noncompliant PCI devices. Static resources are also reserved. Function 2 searches for and initializes any PnP, PCI, or AGP video devices.
38	Initialize different buses and perform the following functions: Boot Input Device Initialization (function 3); IPL Device Initialization (function 4); General Device Initialization (function 5). Function 3 searches for and configures PCI input devices and detects if system has standard keyboard controller. Function 4 searches for and configures all PnP and PCI boot devices. Function 5 configures all onboard peripherals that are set to an automatic configuration and configures all remaining PnP and PCI devices.

While control is in the different functions, additional checkpoints are output to port 80h as a word value to identify the routines under execution. The low byte value indicates the main POST Code Checkpoint. The high byte is divided into two nibbles and contains two fields. The details of the high byte of these checkpoints are as follows:

HIGH BYTE XY

The upper nibble 'X' indicates the function number that is being executed. 'X' can be from 0 to 7.

- 0 = func#0, disable all devices on the BUS concerned.
- 1 = func#1, static devices initialization on the BUS concerned.
- 2 = func#2, output device initialization on the BUS concerned.
- 3 = func#3, input device initialization on the BUS concerned.
- 4 = func#4, IPL device initialization on the BUS concerned.
- 5 = func#5, general device initialization on the BUS concerned.
- 6 = func#6, error reporting for the BUS concerned.
- 7 = func#7, add-on ROM initialization for all BUSes.
- 8 = func#8, BBS ROM initialization for all BUSes.

The lower nibble 'Y' indicates the BUS on which the different routines are being executed. 'Y' can be from 0 to 5.

- 0 = Generic DIM (Device Initialization Manager).
- 1 = On-board System devices.
- 2 = ISA devices.
- 3 = EISA devices.
- 4 = ISA PnP devices.
- 5 = PCI devices.

Beep Codes

Beep codes are used by the BIOS to indicate a serious or fatal error to the end user. Beep codes are used when an error occurs before the system video has been initialized. Beep codes will be generated by the system board speaker, commonly referred to as the PC speaker.

AMIBIOS displays the checkpoints in the bottom right corner of the screen during POST. This display method is limited, since it only displays checkpoints that occur after the video card has been activated.

Not all computers using AMIBIOS enable this feature. In most cases, a checkpoint card is the best tool for viewing AMIBIOS checkpoints.

Beep Symptom	Cause and Description
One short beep	System is ready. System is OK.
Continuous one long beep	Memory not installed or memory error.
One long beep and two short beeps then repeat.	VGA not installed or VGA error. Graphics card error/not installed, graphics card memory error or graphics card BIOS checksum error.
One long beep then two short beep	BIOS damaged. BIOS is damaged, BIOS POST jumps to Boot Block to execute the default procedures.
Two short beeps	CMOS damaged. CMOS checksum error or CMOS battery loss occurs.

Boot Block Beep Codes

Number of Beeps	Description
1	No media present. Insert diskette in floppy drive A:
2	'AMIBOOT.ROM' file not found in root directory of diskette in A:
3	Insert next diskette if multiple diskettes are used for recovery
4	Flash Programming successful
5	Floppy read error
7	No Flash EPROM detected
10	Flash Erase error
11	Flash Program error
12	'AMIBOOT.ROM' file size error
13	BIOS ROM image mismatch (file layout does not match image present in flash device)

POST BIOS Beep Codes

Number of Beeps	Description
1	Memory refresh timer error.
3	Base memory read/write test error
6	Keyboard controller BAT command field
7	General exception error (processor exception interrupt error)
8	Display memory error (system video adapter)

Troubleshooting POST BIOS Beep Codes

Number of Beeps	Description
1,3	Reseat the memory, or replace with known good modules.
6,7	<p>Fatal error indicating a serious problem with the system. Consult your system manufacturer. Before declaring the motherboard beyond all hope, eliminate the possibility of interference by a malfunctioning add-in card. Remove all expansion cards except the video adapter.</p> <ul style="list-style-type: none"><li data-bbox="425 358 1312 419">q If beep codes are generated when all other expansion cards are absent, consult your system manufacturer's technical support.<li data-bbox="425 425 1312 548">q If beep codes are not generated when all other expansion cards are absent, one of the add-in cards is causing the malfunction. Insert the cards back into the system one at a time until the problem happens again. This will reveal the malfunctioning card.
8	If the system video adapter is an add-in card, replace or reseat the video adapter. If the video adapter is an integrated part of the system board, the board may be faulty.

Error Messages

The following tables describes the error messages that may appear during POST. Each message is listed with a detailed description of the error.

Memory

Message Displayed	Description
Gate20 Error	The BIOS is unable to properly control the motherboard's Gate A20 function, which controls access of memory over 1 MB. This may indicate a problem with the motherboard.
Multi-Bit ECC Error	This message will only occur on systems using ECC enabled memory modules. ECC memory has the ability to correct single-bit errors that may occur from faulty memory modules. A multiple bit corruption of memory has occurred, and the ECC memory algorithm cannot correct it. This may indicate a defective memory module.
Parity Error	Fatal Memory Parity Error. System halts after displaying this message.
RAM R/W test failed	This message is displayed by the AMIBIOS8 when the RAM read/write test fails.
CMOS Memory Size Wrong	The base memory (memory below 1MB) size that is reported in the CMOS (offset 15h) mismatches with the actual size detected. This condition may occur when the hole is set at 512K base memory or when CMOS is corrupted.

Boot

Message Displayed	Description
Boot Failure ...	This is a generic message indicating the BIOS could not boot from a particular device. This message is usually followed by other information concerning the device.
Invalid Boot Diskette	A diskette was found in the drive, but it is not configured as a bootable diskette.
Drive Not Ready	The BIOS was unable to access the drive because it indicated it was not ready for data transfer. This is often reported by drives when no media is present.
A: Drive Error	The BIOS attempted to configure the A: drive during POST, but was unable to properly configure the device. This may be due to a bad cable or faulty diskette drive.
B: Drive Error	The BIOS attempted to configure the B: drive during POST, but was unable to properly configure the device. This may be due to a bad cable or faulty diskette drive.
Insert BOOT diskette in A:	The BIOS attempted to boot from the A: drive, but could not find a proper boot diskette. Reboot and Select proper Boot device or Insert Boot Media in selected Boot device BIOS could not find a bootable device in the system and/or removable media drive does not contain media.
NO ROM BASIC	This message occurs on some systems when no bootable device can be detected.

Storage Device

Message Displayed	Description
Primary Master Hard Disk Error	The IDE/ATAPI device configured as Primary Master could not be properly initialized by the BIOS. This message is typically displayed when the BIOS is trying to detect and configure IDE/ATAPI devices in POST.
Primary Slave Hard Disk Error	The IDE/ATAPI device configured as Primary Slave could not be properly initialized by the BIOS. This message is typically displayed when the BIOS is trying to detect and configure IDE/ATAPI devices in POST.
Secondary Master Hard Disk Error	The IDE/ATAPI device configured as Secondary Master could not be properly initialized by the BIOS. This message is typically displayed when the BIOS is trying to detect and configure IDE/ATAPI devices in POST.
Secondary Slave Hard Disk Error	The IDE/ATAPI device configured as Secondary Slave could not be properly initialized by the BIOS. This message is typically displayed when the BIOS is trying to detect and configure IDE/ATAPI devices in POST.
3rd Master Hard Disk Error	The IDE/ATAPI device configured as Master in the 3rd IDE controller could not be properly initialized by the BIOS. This message is typically displayed when the BIOS is trying to detect and configure IDE/ATAPI devices in POST.
3rd Slave Hard Disk Error	The IDE/ATAPI device configured as Slave in the 3rd IDE controller could not be properly initialized by the BIOS. This message is typically displayed when the BIOS is trying to detect and configure IDE/ATAPI devices in POST.
4th Master Hard Disk Error	The IDE/ATAPI device configured as Master in the 4th IDE controller could not be properly initialized by the BIOS. This message is typically displayed when the BIOS is trying to detect and configure IDE/ATAPI devices in POST.
4th Slave Hard Disk Error	The IDE/ATAPI device configured as Slave in the 4th IDE controller could not be properly initialized by the BIOS. This message is typically displayed when the BIOS is trying to detect and configure IDE/ATAPI devices in POST.
5th Master Hard Disk Error	The IDE/ATAPI device configured as Master in the 5th IDE controller could not be properly initialized by the BIOS. This message is typically displayed when the BIOS is trying to detect and configure IDE/ATAPI devices in POST.
5th Slave Hard Disk Error	The IDE/ATAPI device configured as Slave in the 5th IDE controller could not be properly initialized by the BIOS. This message is typically displayed when the BIOS is trying to detect and configure IDE/ATAPI devices in POST.
6th Master Hard Disk Error	The IDE/ATAPI device configured as Master in the 6th IDE controller could not be properly initialized by the BIOS. This message is typically displayed when the BIOS is trying to detect and configure IDE/ATAPI devices in POST.
6th Slave Hard Disk Error	The IDE/ATAPI device configured as Slave in the 6th IDE controller could not be properly initialized by the BIOS. This message is typically displayed when the BIOS is trying to detect and configure IDE/ATAPI devices in POST.
Primary Master Drive - ATAPI Incompatible	The IDE/ATAPI device configured as Primary Master failed an ATAPI compatibility test. This message is typically displayed when the BIOS is trying to detect and configure IDE/ATAPI devices in POST.
Primary Slave Drive - ATAPI Incompatible	The IDE/ATAPI device configured as Primary Slave failed an ATAPI compatibility test. This message is typically displayed when the BIOS is trying to detect and configure IDE/ATAPI devices in POST.
Secondary Master Drive - ATAPI Incompatible	The IDE/ATAPI device configured as Secondary Master failed an ATAPI compatibility test. This message is typically displayed when the BIOS is trying to detect and configure IDE/ATAPI devices in POST.
Secondary Slave Drive - ATAPI Incompatible	The IDE/ATAPI device configured as Secondary Slave failed an ATAPI compatibility test. This message is typically displayed when the BIOS is trying to detect and configure IDE/ATAPI devices in POST.
3rd Master Drive - ATAPI Incompatible	The IDE/ATAPI device configured as Master in the 3rd IDE controller failed an ATAPI compatibility test. This message is typically displayed when the BIOS is trying to detect and configure IDE/ATAPI devices in POST.

Message Displayed	Description
3rd Slave Drive - ATAPI Incompatible	The IDE/ATAPI device configured as Slave in the 3rd IDE controller failed an ATAPI compatibility test. This message is typically displayed when the BIOS is trying to detect and configure IDE/ATAPI devices in POST.
4th Master Drive - ATAPI Incompatible	The IDE/ATAPI device configured as Master in the 4th IDE controller failed an ATAPI compatibility test. This message is typically displayed when the BIOS is trying to detect and configure IDE/ATAPI devices in POST.
4th Slave Drive - ATAPI Incompatible	The IDE/ATAPI device configured as Slave in the 4th IDE controller failed an ATAPI compatibility test. This message is typically displayed when the BIOS is trying to detect and configure IDE/ATAPI devices in POST.
5th Master Drive - ATAPI Incompatible	The IDE/ATAPI device configured as Master in the 5th IDE controller failed an ATAPI compatibility test. This message is typically displayed when the BIOS is trying to detect and configure IDE/ATAPI devices in POST.
5th Slave Drive - ATAPI Incompatible	The IDE/ATAPI device configured as Slave in the 5th IDE controller failed an ATAPI compatibility test. This message is typically displayed when the BIOS is trying to detect and configure IDE/ATAPI devices in POST.
6th Master Drive - ATAPI Incompatible	The IDE/ATAPI device configured as Master in the 6th IDE controller failed an ATAPI compatibility test. This message is typically displayed when the BIOS is trying to detect and configure IDE/ATAPI devices in POST.
6th Slave Drive - ATAPI Incompatible	The IDE/ATAPI device configured as Slave in the 6th IDE controller failed an ATAPI compatibility test. This message is typically displayed when the BIOS is trying to detect and configure IDE/ATAPI devices in POST.
S.M.A.R.T. Capable but Command Failed	The BIOS tried to send a S.M.A.R.T. message to a hard disk, but the command transaction failed. This message can be reported by an ATAPI device using the S.M.A.R.T. error reporting standard. S.M.A.R.T. failure messages may indicate the need to replace the hard disk.
S.M.A.R.T. Command Failed	The BIOS tried to send a S.M.A.R.T. message to a hard disk, but the command transaction failed. This message can be reported by an ATAPI device using the S.M.A.R.T. error reporting standard. S.M.A.R.T. failure messages may indicate the need to replace the hard disk.
S.M.A.R.T. Status BAD, Backup and Replace	A S.M.A.R.T. capable hard disk sends this message when it detects an imminent failure. This message can be reported by an ATAPI device using the S.M.A.R.T. error reporting standard. S.M.A.R.T. failure messages may indicate the need to replace the hard disk.
S.M.A.R.T. Capable and Status BAD	A S.M.A.R.T. capable hard disk sends this message when it detects an imminent failure. This message can be reported by an ATAPI device using the S.M.A.R.T. error reporting standard. S.M.A.R.T. failure messages may indicate the need to replace the hard disk.

Virus Related

Message Displayed	Description
BootSector Write !!	The BIOS has detected software attempting to write to a drive's boot sector. This is flagged as possible virus activity. This message will only be displayed if Virus Detection is enabled in AMIBIOS setup.
VIRUS: Continue (Y/N)?	If the BIOS detects possible virus activity, it will prompt the user. This message will only be displayed if Virus Detection is enabled in AMIBIOS setup.

System Configuration

Message Displayed	Description
DMA-1 Error	Error initializing primary DMA controller. This is a fatal error, often indication a problem with system hardware.
DMA-2 Error	Error initializing secondary DMA controller. This is a fatal error, often indication a problem with system hardware.
DMA Controller Error	POST error while trying to initialize the DMA controller. This is a fatal error, often indication a problem with system hardware.
Checking NVRAM..Update Failed	BIOS could not write to the NVRAM block. This message appears when the FLASH part is write-protected or if there is no FLASH part (System uses a PROM or EPROM).
Microcode Error	BIOS could not find or load the CPU Microcode Update to the CPU. This message only applies to INTEL CPUs. The message is most likely to appear when a brand new CPU is installed in a motherboard with an outdated BIOS. In this case, the BIOS must be updated to include the Microcode Update for the new CPU.
NVRAM Checksum Bad, NVRAM Cleared	There was an error in while validating the NVRAM data. This causes POST to clear the NVRAM data.
Resource Conflict	More than one system device is trying to use the same non-shareable resources (Memory or I/O).
NVRAM Ignored	The NVRAM data used to store Plug'n'Play (PnP) data was not used for system configuration in POST.
NVRAM Bad	The NVRAM data used to store Plug'n'Play (PnP) data was not used for system configuration in POST due to a data error.
Static Resource Conflict	Two or more Static Devices are trying to use the same resource space (usually Memory or I/O).
PCI I/O conflict	A PCI adapter generated an I/O resource conflict when configured by BIOS POST.
PCI ROM conflict	A PCI adapter generated an I/O resource conflict when configured by BIOS POST.
PCI IRQ conflict	A PCI adapter generated an I/O resource conflict when configured by BIOS POST.
PCI IRQ routing table error	BIOS POST (DIM code) found a PCI device in the system but was unable to figure out how to route an IRQ to the device. Usually this error is causing by an incomplete description of the PCI Interrupt Routing of the system.
Timer Error	Indicates an error while programming the count register of channel 2 of the 8254 timer. This may indicate a problem with system hardware.
Refresh timer test failed	BIOS POST found that the refresh timer hardware failed to pass the Refresh Retrace Test.
Interrupt Controller-1 error	BIOS POST could not initialize the Master Interrupt Controller. This may indicate a problem with system hardware.

CMOS

Message Displayed	Description
CMOS Date/Time Not Set	The CMOS Date and/or Time are invalid. This error can be resolved by readjusting the system time in AMIBIOS Setup.
CMOS Battery Low	CMOS Battery is low. This message usually indicates that the CMOS battery needs to be replaced. It could also appear when the user intentionally discharges the CMOS battery.
CMOS Settings Wrong	CMOS settings are invalid. This error can be resolved by using AMIBIOS Setup.
CMOS Checksum Bad	CMOS contents failed the Checksum check. Indicates that the CMOS data has been changed by a program other than the BIOS or that the CMOS is not retaining its data due to malfunction. This error can typically be resolved by using AMIBIOS Setup.

Miscellaneous

Message Displayed	Description
KBC BAT Test failed	Keyboard controller BAT test failed. This may indicate a problem with keyboard controller initialization.
Keyboard Error	Keyboard is not present or the hardware is not responding when the keyboard controller is initialized.
PS2 Keyboard not found	PS2 Keyboard support is enabled in the BIOS setup but the device is not detected.
PS2 Mouse not found	PS2 Mouse support is enabled in the BIOS setup but the device is not detected.
Keyboard/Interface Error	Keyboard Controller failure. This may indicate a problem with system hardware.
Unlock Keyboard	PS2 keyboard is locked. User needs to unlock the keyboard to continue the BIOS POST.
System Halted	The system has been halted. A reset or power cycle is required to reboot the machine. This message appears after a fatal error has been detected.
<INS> Pressed	Indicates that <INS> key is pressed during the BIOS POST. The POST will load and use default CMOS settings.
Password check failed	The password entered does not match the password set in the setup. This condition may occur for both Supervisor and User password verification.
Unknown BIOS error. Error code = 004Ah	This message is displayed when ADM module is not present in the AMIBIOS8 ROM.
Unknown BIOS error. Error code = 004Bh	This message is displayed when language module is not present in the AMIBIOS8 ROM.
Floppy Controller Failure	Error in initializing legacy Floppy Controller.

USB eModule Error Messages

Message Displayed	Description
Warning! Unsupported USB device found and disabled!	This message is displayed when a non-bootable USB device is enumerated and disabled by the BIOS.
Warning! Port 60h/64h emulation is not supported by this USB Host Controller!	This message is displayed to indicate that port 60h/64h emulation mode cannot be enabled for this USB host controller. This condition occurs if USB KBC emulation option is set for non-SMI mode.
Warning! EHCI controller disabled. It requires 64bit data support in the BIOS.	This message is displayed to indicate that EHCI controller is disabled because of incorrect data structure. This condition occur if the USB host controller needs 64-bit data structure while the USB is ported with 32-bit data structure.

SMBIOS eModule Error Messages

Message Displayed	Description
Not enough space in Runtime area!! SMBIOS data will not be available.	This message is displayed when the size of the SMBIOS data exceeds the available SMBIOS runtime storage size.

CPU eModule Error Messages

Message Displayed	Description
Warning! This system board does not support the power requirements of the installed processor. The processor will be run at a reduced frequency, which will impact system performance.	This message is displayed when the power requirements of the board do not match the power requirement of the CPU.

MPS Table (Multi-processor) eModule Error Messages

Message Displayed	Description
Insufficient Runtime space for MPS data! System may operate in PIC or Non-MPS mode.	This message is displayed when there is not enough space in the 0F000h runtime area for creating MPS table.

Online Support Information

This section describes online technical support services available to help you repair the desktop computer.

If you are a distributor, dealer, ASP or TPM, please refer your technical queries to your local Acer branch office. Acer Branch Offices and Regional Business Units may access our website at <http://global.acer.com/support/index>. However some information sources will require a user ID and password. These can be obtained directly from Acer CSD Taiwan.

Acer's Website offers you convenient and valuable support resources whenever you need them.

In the Support & Downloads tab you can download information materials for all of Acer notebook, desktop and server models including:

- q Service guides for all models
- q User's manuals
- q Training materials
- q BIOS updates
- q Software utilities
- q Spare parts lists
- q Technical Announcement Bulletins (TABs)

For these purposes, we have included an Acrobat File to facilitate a hassle-free downloading of our technical materials.

The following are also available in the Support & Downloads tab:

- q Detailed information on Acer's International Traveler's Warranty (ITW)
- q Returned material authorization procedures
- q An overview of all the support services we offer, accompanied by a list of telephone, fax, and email contacts for all your technical queries.

We are always looking for ways to optimize and improve our services, so if you have any suggestions or comments, please do not hesitate to communicate these to us.

System Block Diagram and Board Layout

System Block Diagram

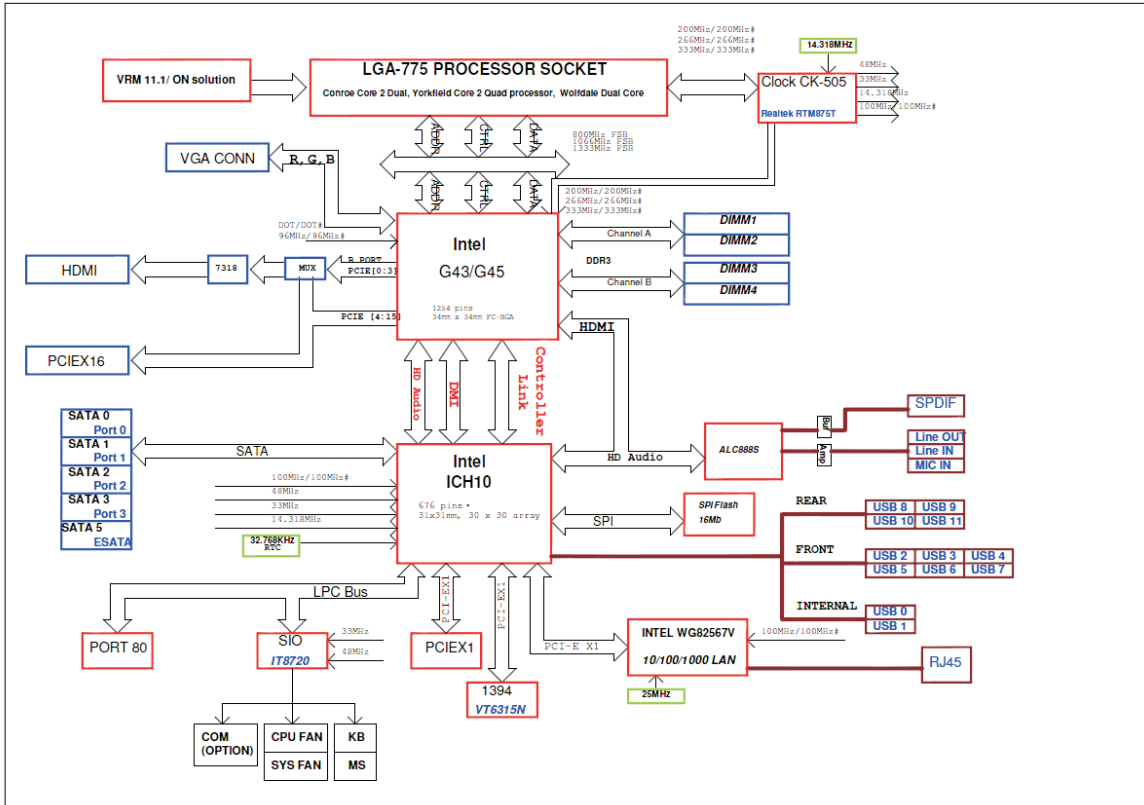

Board Layout

Mainboard

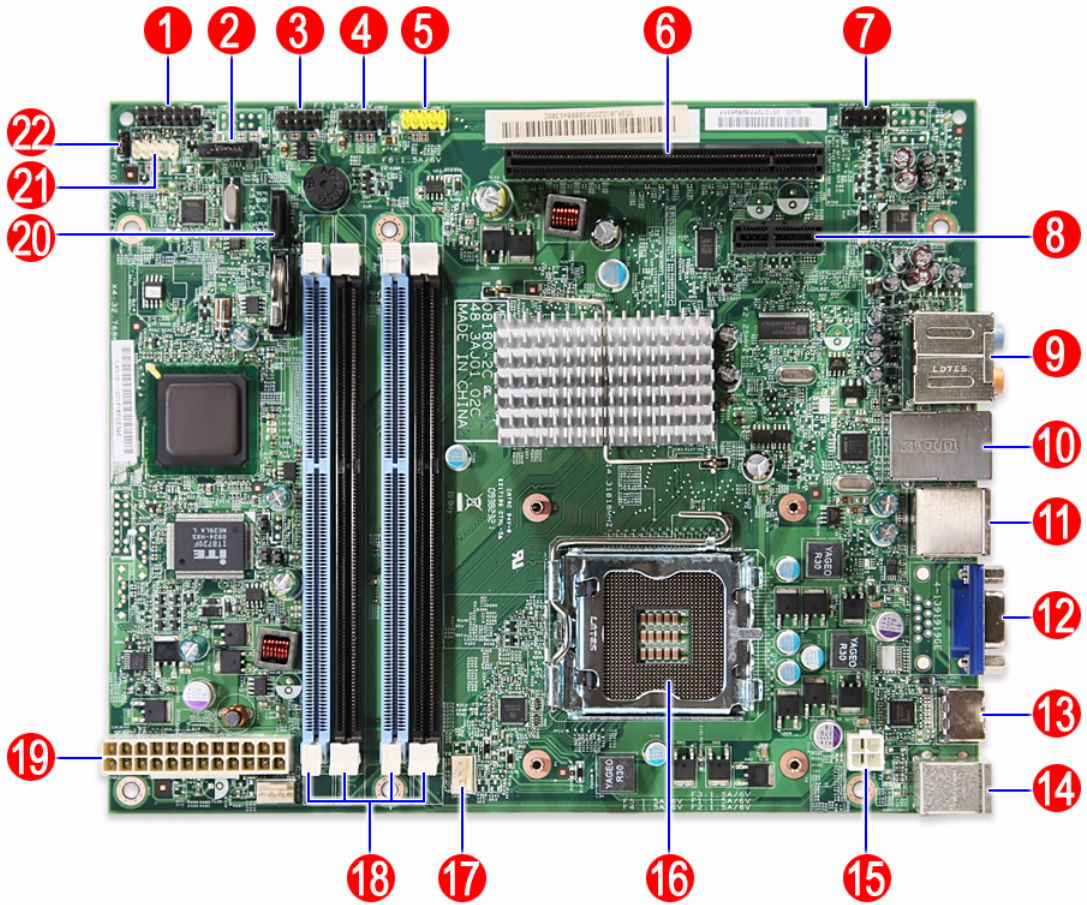

No	Code	Description
1	LEDH1	Power and switch LED cable connector
2	SATA3	SATA 3 connector
3	USBF3	Front USB connector
4	USBF2	Front USB connector
5	USBF1	Front USB connector
6	PCIEX1	PCI Express x16 slot
7	AUDIOF1	Front audio connector
8	PCIE1	PCI Express x1 slot
9	AUDJACK1	Audio 7.1 channel
10	USBLAN1	Top: Gigabit LAN port Bottom: USB ports
11	USBESATA1	Top: USB ports Bottom: eSATA port
12	VGA1	VGA (D-sub) port
13	HDMI1	HDMI port

No	Code	Description
14	KBMSCONN1	Top: PS2 Mouse port Bottom: PS2 Keyboard port
15	PWR1	4-pin ATX power connector
16	U17	Processor socket
17	CPU FAN1	Processor fan connector
18	DIMM 1-4	DIMM slots
19	PWR2	24-pin ATX power connector
20	SATA0	SATA 0 connector
21	FIREH1	1394 connector
22	JBIOS1	Clear CMOS/NVRAM jumper

System Jumper

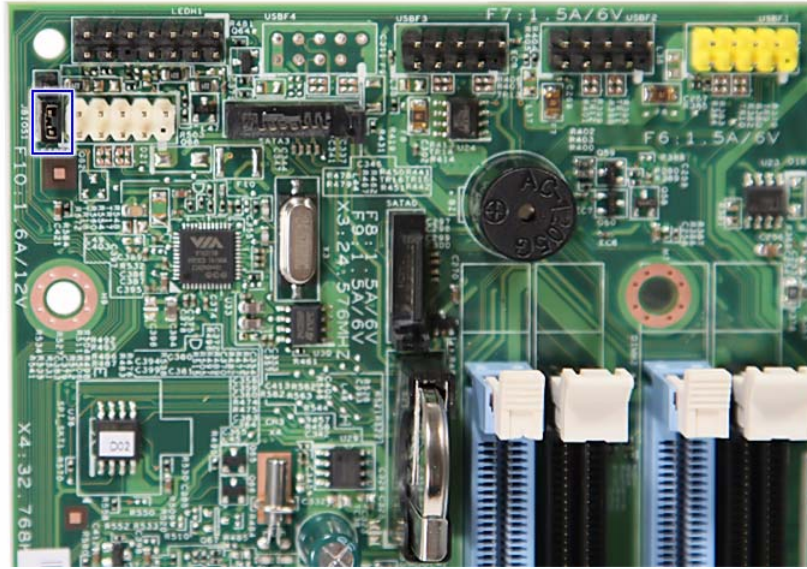

Name	Location	Default	Settings
Clear CMOS/NVRAM	JBIOS1	1-2 2-3	Normal (default) Clear CMOS/NVRAM

FRU (Field Replaceable Unit) List

This chapter offers the FRU (Field Replaceable Unit) list in global configuration of the X3810/X5810 desktop computer. Refer to this chapter whenever ordering the parts to repair or for RMA (Return Merchandise Authorization).

NOTES:



- When ordering FRU parts, check the most up-to-date information available on your regional web or channel. For whatever reasons a part number is changed, it will NOT be noted on the printed Service Guide. For Acer authorized service providers, your Acer office may have a different part number code from those given in the FRU list of this printed Service Guide. You MUST use the local FRU list provided by your regional Acer office to order FRU parts for service.
- To scrap or to return the defective parts, follow the local government ordinance or regulations on how to dispose it properly, or follow the rules set by your regional Acer office on how to return it.
- This document will be updated as more information about the FRU list becomes available.

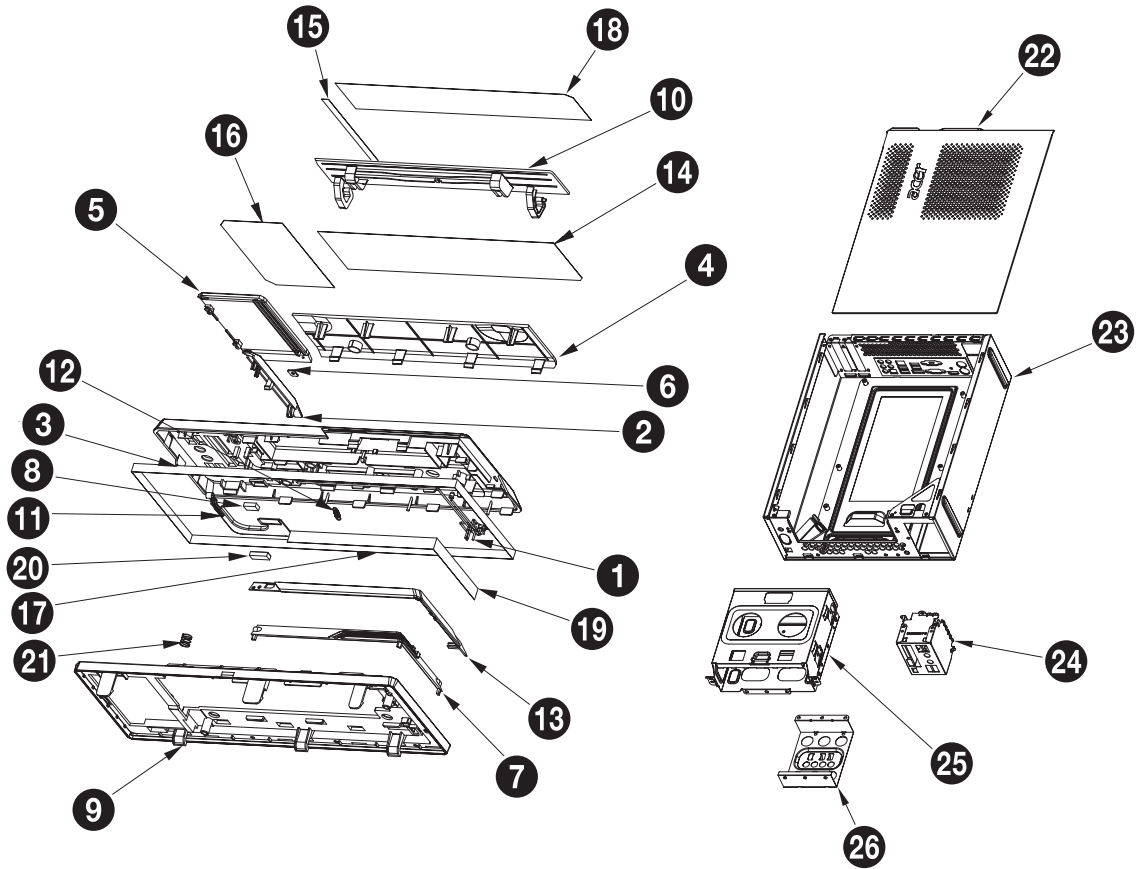



X3910 Exploded Diagram



No.	Part Name
1	C.A LED POWER SWITCH
2	EJECT BUTTON
3	FRONT BEZEL
4	FRONT COVER
5	IO DOOR
6	IO DOOR BKT
7	LENS POWER
8	MAGNET 10*6*3
9	MIDDLE BEZEL
10	ODD DOOR
11	ODD LINK BKT
12	ODD DOOR SPRING
13	POWER BUTTON
14	PROTECTFILM BEZEL-CVR
15	PROTECTFILM EJECT
16	PROTECTFILM IO DOOR
17	PROTECTFILM MID BZL
18	PROTECTFILM ODD DOOR
19	PROTECTFILM POWER
20	RUB ODD LINK
21	SPG ODD BUTTON BOXER
22	ASSEMBLY L CASE - ASM
23	ASSEMBLY U CASE - ASM
24	FRONT IO BRACKET
25	ODD BRACKET
26	HDD BRACKET

X3910 FRU List

Category	Part Name	Acer Part Number
ACCESSORY		
REMOTE CONTROLLER	REMOTE CONTROLLER SMK VISTA MCE ICONIZED RC WITH 2 BATTERIES FOR EMEA	RT.11300.001
	REMOTE CONTROLLER SMK VISTA MCE ICONIZED RC WITH 2 BATTERIES FOR US	RT.11300.002
	REMOTE CONTROLLER RC SMK VISTA MCE-TC EDITION WITH 2 BATTERIES	RT.11300.003
	REMOTE CONTROLLER RC SMK VISTA MCE-SC EDITION WITH 2 BATTERIES	RT.11300.004
	REMOTE CONTROLLER PHILIPS RC1534515 WITH 2 BATTERIES FOR EMEA(VISTA MCE ICONIZED)	RT.11300.005
	REMOTE CONTROLLER PHILIPS RC1534046 WITH 2 BATTERIES FOR US (VISTA MCE ICONIZED)	RT.11300.006
	REMOTE CONTROLLER PHILIPS RC1534052/01BG VISTA MCE-TC EDITION WITH 2 BATTERIES	RT.11300.007
	REMOTE CONTROLLER PHILIPS RC1534051/01BG VISTA MCE-SC EDITION WITH 2 BATTERIES	RT.11300.008
	REMOTE CONTROL PHILIPS VISTA FOR OVU71	RT.11300.009
	REMOTE CONTROL HID SMK RRS9003-0501EC	RT.11300.010
RECEIVER	RECEIVER PHILIPS VISTA MCE TRANSCEIVER WITH 1 BLASTER OVU412000	RV.11000.003
	RECEIVER SMK RECEIVER VISTA MCE RECEIVER WITH ONE IR BLASTER	RV.11000.004
	RECEIVER PHILIPS VISTA OVU71	RV.11000.007
	RECEIVER SMK VISTA OVU71	RV.11000.011
BOARDS		
	WIRELESS PCI CARD PRO-NETS WU61RL USB RALINK CHIPSET 802.11 B/G	NI.10200.002
	WIRELESS LAN BOARD 802.11BGN LITEON WN7600R	NI.10200.009
	WIRELESS LAN BOARD 802.11BGN PRONETS WU71RL USB	NI.10200.023
	FRONT IO BOARD W/AUDIO CABLE*1&USB CABLE*2	55.SCF01.001
	CARD READER 5 IN 1 8.5L W/USB2.0&1394X1&USBX1&CABLE REALTEK RTS-5151-DE	CR.10400.088
	CARD READER 9 IN 1 8.5L W/USB2.0&1394X1&USBX1&CABLE REALTEK RTS-5151-D	CR.10400.084
	CARD READER 9 IN 1 8.5L W/USB2.0&1394X1&USBX1&CABLE REALTEK RTS-5151-DE	CR.10400.083
	VGA CARD GEFORCE GT120 1GB 128BITS DDR II SAMSUNG DVI HDMI LP PCB 55NM WITH LP BRACKET	VG.PCGT1.213
	VGA CARD PCPARTNER GT100 512MB 64BITS DDR II SAMSUNG DVI VGA HDMI WITH 1 LP BRACKET	VG.PCGT1.L02
	VGA CARD PC PARTNER 288-30E99-B01AC HD4350 512MB DDR II 32BITS SAMSUNG DVI HDMI WITH 1LP BKT ROHS	VG.APC43.5L2

Category	Part Name	Acer Part Number
	MODEM CARD LITE-ON D-1156E#A10A LOW-PROFILE PCI-E 56K V.92	FX.10100.003
	MODEM CARD 56K PRO-NETS LSI HPE56L6 (LO)	FX.10100.021
	MODEM CARD 56K PRO-NETS USB	FX.10100.001
	TV TUNER CARD PCIE SINGLE ISDB-T	TU.10500.037
	TV TUNER CARD YUAN PE988-D PCI	TU.10500.042
	TV TUNER CARD YUAN PE988-A PC	TU.10500.041
CABLES		
	VGA SPDIF CABLE	D0.DVI01.N02
	SATA ODD SATA CABLE	50.SC101.002
	SATA ODD SATA CABLE	50.G8101.001
	HDD SATA CABLE	50.SC101.003
	HDD SATA CABLE	50.G8101.002
	POWER SWITCH&LED CABLE	50.SC101.004
	POWER CORD 110V 3PIN UL USA	27.01518.011
	POWER CORD 250V 3PIN BRAZIL	27.01518.0R1
	POWER CORD 125V 7A 3G JAPAN	27.01518.181
	POWER CORD 125V 10A BLACK MEXICO	27.01518.A01
	POWER CORD 250V 3PIN 1800MM UK	27.03118.031
CASE/COVER/BRACKET ASSEMBLY		
	FRONT BEZEL W/POWER SWITCH&LED CABLE	60.SE201.004
	FRONT IO BRACKET	33.SE301.001
	ASSY MAIN-CHASSIS BOXER X350	60.SE201.001
	UPPER CASE	60.SE201.002
	LOWER CASE	60.SE201.003
	HDD&ODD COVER BRACKET	33.SC101.002
	DVI TO VGA DONGLE CONNECTOR	D0.VGA26.P01

Category	Part Name	Acer Part Number
COMBO MODULE/ DVD-ROM DRIVE		
	ODD HLDS BD COMBO SATA HH DL 4X CH10F LF W/BRACK BEZEL SATA	KO.00605.001
	ODD PIONEER BD COMBO SATA HH DL 4X BDC-203RS W/BACKET BEZEL SATA	KO.0060D.001
	ODD BLU-RAY DISC REWRITER SATA HLDS GBW-H20N	KU.0060D.001
	ODD PLDS DVD-ROM HH 16X DH-16D4S SATA	KV.0160D.015
	ODD HLDS DVD-ROM HH 16X DH10N SATA	KV.0160F.001
	DVD-RW HLDS SUPER-MULTI DRIVE HH HLDS 16X GH-40F LF BLACK BEZEL	KU.0160E.015
	DVD-RW PHILIPS SUPER-MULTI DRIVE HH DL 16X DH-16A6S LF BLACK BEZEL	KU.0160D.045
	ODD SONY SUPER-MULTI DRIVE HH 16X AD-7203S LF SATA	KU.0160F.005
CPU/PROCESSOR		
	CPU INTEL CELERON DUA CORE E1400 2.0G 512K 800FSB CDE1400 893845 SLAR2 M0	KC.14001.CDE
	CPU INTEL CELERON DUA CORE E1500 2.2G 512K 800FSB 65W	KC.15001.CDE
	CPU INTEL PENTIUM DUAL CORE E5200 2.5G 2M 800FSB 65W EU80571PG0602M 896940 SLAY7	KC.52001.DEM
	CPU INTEL PENTIUM E5300 2.6G PGA	KC.53001.DEM
	CPU INTEL PENTIUM E5400 2.7G 2M 800FSB 65W	KC.54001.DEM
	CPU INTEL CORE2QUAD Q6600 LGA 2.4G 2X4M 1066 775 95W G-0	KC.66001.QQG
	CPU INTEL WOLFDAL E7400 2.8G PGA	KC.74001.DE0
	CPU INTEL CORE2QUAD Q8200 2.33G 4M 1333FSB 95W M1 EU80580PJ0534MN 898065 SLB5M	KC.82001.QQ0
	CPU INTEL YORKFIELD Q8300 2.5G 4M 1333FSB 95W	KC.83001.QQ0
	CPU INTEL WOLFDAL E8500 3.16G 6M 1333FSB 65W	KC.85001.DEE
	CPU INTEL WOLFDAL E8600 3.33G 6M 1333FSB 65W	KC.86001.DEE
	CPU INTEL CORE2QUAD Q9300 PGA 2.5G 1333 775 95W 6M	KC.93001.QQ0
	CPU INTEL CORE2QUAD Q9400 2.66G 6M 1333FSB 95W R0 AT80580PJ0676M 898380 SLB6B	KC.94001.QQ0
	CPU INTEL YORKFIELD 2.83G Q9650 12M 1333FSB 95W	KC.95501.QQE
	CPU INTEL 3.0G YORKFIELD Q9650 AT80569PJ080N 898652 SLB8W	KC.96501.QQE
HDD/HARD DISK DRIVE		
	HDD 160GB 3.5" 7200RPM SATA II SEAGATE ST3160815AS	KH.16001.031
	HDD 160GB 3.5" 7200RPM SATA II HGST HDT721016SLA380	KH.16007.023
	HDD 160GB 3.5" 7200RPM SATA II WD WD1600AAJS-22L7A0 XL320S-3	KH.16008.025
	HDD 320GB 3.5" 7200RPM SATA II 8MB HGST HDT721032SLA380 SATURN	KH.32007.006
	HDD 320GB 3.5" 7200RPM SATA II WD WD3200AAJS-22L7A0 XL320S	KH.32008.016
	HDD 640GB 3.5" 7200RPM SEAGATE ST3640623AS BRINKS SATA II 16MB LF F/W:SD43	KH.64001.001
	HDD 640GB 3.5" 7200RPM HGST HDT721064SLA360 SATURN SATA	KH.64007.001
	HDD 640GB 3.5" 7200RPM SATA II WD WD6400AAKS-22A7B2 XL320-M	KH.64008.003
	HDD 1TB 3.5" 5400RPM SATA WD WD10EAVS-00D7B1 GP333M	KH.01K08.003
	HDD 1TB 3.5" 7200RPM SATA HGST SATURN HDT721010SLA360	KH.01K07.002
	HDD 2TB 3.5" 5400RPM SATA WD GP500M WD20EADS-22R6B0 GP	KH.02K08.001
	HEATSINK	

Category	Part Name	Acer Part Number
	CPU HEATSINK AIR COOLER LGA775 TMDC6 NEW SPRIG	HI.10800.028
KEYBOARD		
	KEYBOARD PS2 104KEY CHICONY KB-07593US2552V US2552V US BLAC	KB.PS203.096
	KEYBOARD PS2 104KEY CHICONY KB-07593RD2552V TRADITIONAL CHINESE BLACK	KB.PS203.097
	KEYBOARD PS2 104KEY CHICONY KB-07593RE2552V SIMPLE CHINESE BLACK	KB.PS203.098
	KEYBOARD PS2 104KEY CHICONY KB-07593U42552V US-I BLACK	KB.PS203.099
	KEYBOARD PS2 104KEY CHICONY KB-07593A02552V ARABIC/ENGLISH	KB.PS203.100
	KEYBOARD PS2 104KEY CHICONY KB-07593T02552V THAI BLACK	KB.PS203.101
	KEYBOARD PS2 105KEY CHICONY KB-07596E02552V SPANISH BLACK	KB.PS203.102
	KEYBOARD PS2 105KEY CHICONY KB-07596P02552V PORTUGUESE BLACK	KB.PS203.103
	KEYBOARD PS2 105KEY CHICONY KB-07596CA2552V CANADA/FRENCH	KB.PS203.104
	KEYBOARD PS2 107KEY CHICONY KB-07598PA2552V BRAZILIAN PORTU	KB.PS203.105
	KEYBOARD PS2 109KEY CHICONY KB-07590J02552V JAPANESE BLACK	KB.PS203.106
	KEYBOARD PS2 105KEY CHICONY KB-07596D12552V GERMAN BLACK	KB.PS203.107
	KEYBOARD PS2 105KEY CHICONY KB-07596I02552V ITALIAN BLACK	KB.PS203.108
	KEYBOARD PS2 105KEY CHICONY KB-07596F12552V FRENCH BLACK	KB.PS203.109
	KEYBOARD PS2 105KEY CHICONY KB-07596S02552V SWEDISH BLACK	KB.PS203.110
	KEYBOARD PS2 105KEY CHICONY KB-07596GB2552V UK BLACK	KB.PS203.111
	KEYBOARD PS2 105KEY CHICONY KB-07596NL2552V DUTCH BLACK	KB.PS203.112
	KEYBOARD PS2 105KEY CHICONY KB-07596CH2552V SWISS/G BLACK	KB.PS203.113
	KEYBOARD PS2 105KEY CHICONY KB-07596B02552V BELGIUM BLACK	KB.PS203.114
	KEYBOARD PS2 105KEY CHICONY KB-07596IC2552V ICELANDIC BLACK	KB.PS203.115
	KEYBOARD PS2 105KEY CHICONY KB-07596N02552V NORWEGIAN BLACK	KB.PS203.116
	KEYBOARD PS2 104KEY CHICONY KB-07593HB2552V HEBREW BLACK	KB.PS203.117
	KEYBOARD PS2 105KEY CHICONY KB-07596PL2552V POLISH BLACK	KB.PS203.118
	KEYBOARD PS2 105KEY CHICONY KB-07596YU2552V SLOVENIAN BLACK	KB.PS203.119
	KEYBOARD PS2 105KEY CHICONY KB-07596CL2552V SLOVAK BLACK	KB.PS203.120

Category	Part Name	Acer Part Number
	KEYBOARD PS2 104KEY CHICONY KB-07593S32552V RUSSIAN BLACK	KB.PS203.121
	KEYBOARD PS2 105KEY CHIOCNY KB-07596HU2552V HUNGARIAN BLACK	KB.PS203.122
	KEYBOARD PS2 104KEY CHICONY KB-07593GR2552V GREEK BLACK	KB.PS203.123
	KEYBOARD PS2 105KEY CHICONY KB-07596DK2552V DANISH BLACK	KB.PS203.124
	KEYBOARD PS2 104KEY CHICONY KB-07593C02552V CZECH BLACK	KB.PS203.125
	KEYBOARD PS2 105KEY CHICONY KB-07596R02552V ROMANIAN BLACK	KB.PS203.126
	KEYBOARD PS2 105KEY CHICONY KB-07596TF2552V TURKISH BLACK	KB.PS203.127
	KEYBOARD PS2 105KEY CHICONY KB-07596LA2552V SPANISH LATIN	KB.PS203.128
	KEYBOARD PS2 105KEY CHICONY KB-07596TQ2552V TURKISH-Q BLACK	KB.PS203.129
	KEYBOARD PS2 105KEY CHICONY KB-07596AF2552V ARABIC/FRENCH	KB.PS203.130
	KEYBOARD PS2 105KEY LITE-ON SK-9620 SG-30600-28W TURKISH-Q BLACK VISTA	KB.PS20B.008
	KEYBOARD PS2 105KEY LITE-ON SK-9620 SG-30600-52W ROMANIAN BLACK VISTA	KB.PS20B.005
	KEYBOARD PS2 105KEY LITE-ON SK-9620 SG-30600-41W TURKISH BLACK VISTA	KB.PS20B.006
	KEYBOARD PS2 105KEY LITE-ON SK-9620 SG-30600-29W SPANISH BLACK VISTA	KB.PS20B.007
	KEYBOARD PS2 105KEY LITE-ON SK-9620 SG-30600-28W TURKISH-Q BLACK VISTA	KB.PS20B.008
	KEYBOARD PS2 105KEY LITE-ON SK-9620 SG-30600-2KW DANISH BLACK VISTA	KB.PS20B.009
	KEYBOARD PS2 104KEY LITE-ON SK-9620 SG-30600-XCW CZECH BLACK VISTA	KB.PS20B.010
	KEYBOARD PS2 105KEY LITE-ON SK-9620 SG-30600-24W SLOVAK BLACK VISTA	KB.PS20B.011
	KEYBOARD PS2 104KEY LITE-ON SG-30600-XAW RUSSIAN BLACK VISTA	KB.PS20B.012
	KEYBOARD PS2 105KEY LITE-ON SK-9620 SG-30600-2GW HUNGARIAN BLACK VISTA	KB.PS20B.013
	KEYBOARD PS2 104KEY LITE-ON SK-9620 SG-30600-X2W GREEK BLACK VISTA	KB.PS20B.014
	KEYBOARD PS2 105KEY LITE-ON SK-9620 SG-30600-25W POLISH BLACK VISTA	KB.PS20B.015
	KEYBOARD PS2 105KEY LITE-ON SK-9620 SG-30600-2YW SLOVENIAN BLACK VISTA	KB.PS20B.016
	KEYBOARD PS2 105KEY LITE-ON SK-9620 SG-30600-2JW BELGIUM BLACK VISTA	KB.PS20B.017
	KEYBOARD PS2 105KEY LITE-ON SK-9620 SG-30600-2WW ICELANDIC BLACK VISTA	KB.PS20B.018
	KEYBOARD PS2 105KEY LITE-ON SK-9620 SG-30600-2NW NORWEGIAN BLACK VISTA	KB.PS20B.019
	KEYBOARD PS2 104KEY LITE-ON SK-9620 SG-30600-XTW HEBREW BLACK VISTA	KB.PS20B.020
	KEYBOARD PS2 105KEY LITE-ON SK-9620 SG-30600-2HW DUTCH BLACK VISTA	KB.PS20B.021
	KEYBOARD PS2 105KEY LITE-ON SK-9620 SG-30600-2XW SWISS/G BLACK VISTA	KB.PS20B.022
	KEYBOARD PS2 105KEY LITE-ON SK-9620 SG-30600-2IW ITALIAN BLACK VISTA	KB.PS20B.023
	KEYBOARD PS2 105KEY LITE-ON SK-9620 SG-30600-2FW FRENCH BLACK VISTA	KB.PS20B.024

Category	Part Name	Acer Part Number
	KEYBOARD PS2 105KEY LITE-ON SK-9620 SG-30600-35W SWEDISH BLACK VISTA	KB.PS20B.025
	KEYBOARD PS2 105KEY LITE-ON SK-9620 SG-30600-2BW UK BLACK VISTA	KB.PS20B.026
	KEYBOARD PS2 109KEY LITE-ON SK-9620 SG-30600-2VW JAPANESE BLACK VISTA	KB.PS20B.027
	KEYBOARD PS2 105KEY LITE-ON SK-9620 SG-30600-2DA GERMAN BLACK VISTA	KB.PS20B.028
	KEYBOARD PS2 105KS LITE-ON SK-9620 STANDARD SPANISH BLACK	KB.PS20B.029
	KEYBOARD PS2 105KEY LITE-ON SK-9620 SG-30600-2PW PORTUGUESE BLACK VISTA	KB.PS20B.030
	KEYBOARD PS2 105KEY LITE-ON SK-9620 SG-30600-23W CANADIAN BLACK VISTA	KB.PS20B.031
	KEYBOARD PS2 107KEY LITE-ON SK-9620 SG-30600-40W BRAZILIAN BLACK VISTA	KB.PS20B.032
	KEYBOARD PS2 104KEY LITE-ON SK-9620 SG-30600-X1W RABIC/ ENGLISH BLACK VISTA	KB.PS20B.033
	KEYBOARD PS2 104KEY LITE-ON SK-9620 SG-30600-33W THAILAND BLACK VISTA	KB.PS20B.034
	KEYBOARD PS2 104KEY LITE-ON SK-9620 SG-30600-33W US BLACK VISTA	KB.PS20B.035
	KEYBOARD PS2 104KEY LITE-ON SK-9620 SG-30600-XMW TRADITIONAL CHINESE BLACK VISTA	KB.PS20B.036
	KEYBOARD PS2 104KEY LITE-ON SK-9620 SG-30600-XLW SIMPLIFIED CHINESE BLACK VISTA	KB.PS20B.037
	KEYBOARD PS2 104KEY LITE-ON SK-9620 SG-30601-XUW US INTERNATIONAL BLACK VISTA	KB.PS20B.038
	KEYBOARD PS2 105KEY LITE-ON SK-9620 SG-30600-38W ARABIC/ FRENCH BLACK VISTA	KB.PS20B.039
	KEYBOARD WIRELESS 104KEY CHICONY KG-07663US2552V 2.4G US	KB.RF403.061
	KEYBOARD USB 104KEY CHICONY KU-07603US2552V STANDARD WITH EKEY BLACK	KB.USB03.062
	KEYBOARD USB 104KEY CHICONY KU-07603RD2552V T-CN BLACK	KB.USB03.063
	KEYBOARD USB 104KEY CHICONY KU-07603RE2552V S-CN BLACK	KB.USB03.064
	KEYBOARD USB 104KEY CHICONY KU-07603U42552V US INTERNATIONAL BLACK	KB.USB03.065
	KEYBOARD USB 104KEY CREATIX KU-07603A02552V ARABIC/ENGLISH	KB.USB03.066
	KEYBOARD USB 104KEY CHICONY KU-07603T02552V THAI BLACK	KB.USB03.067
	KEYBOARD USB 105KEY CHICONY KU-07606E02552V SPANISH BLACK	KB.USB03.068
	KEYBOARD USB 105KEY CHICONY KU-07606P02552V PORTUGUESE BLAC	KB.USB03.069
	KEYBOARD USB 105KEY CHICONY KU-07606CA2552V CANADIAN FRENCH BLACK	KB.USB03.070
	KEYBOARD USB 107KEY CHICONY KU-07608PA2552V BRAZILIAN PORTU	KB.USB03.071
	KEYBOARD USB 109KEY CHICONY KU-07600J02552V JAPANESE BLACK	KB.USB03.072
	KEYBOARD USB 105KEY CHICONY KU-07606D12552V GERMAN BLACK	KB.USB03.073
	KEYBOARD USB 105KEY CHICONY KU-07606I02552V ITALIAN BLACK	KB.USB03.074
	KEYBOARD USB 105KEY CHICONY KU-07606F12552V FRENCH BLACK	KB.USB03.075
	KEYBOARD USB 105KEY CHICONY KU-07606S02552V SWEDISH BLACK	KB.USB03.076
	KEYBOARD USB 105KEY CHICONY KU-07606GB2552V UK BLACK	KB.USB03.077
	KEYBOARD USB 105KEY CHICONY KU-07606NL2552V DUTCH BLACK	KB.USB03.078

Category	Part Name	Acer Part Number
	KEYBOARD USB 105KEY CHICONY KU-07606CH2552V SWISS/G BLACK	KB.USB03.079
	KEYBOARD USB 105KEY CHICONY KU-07606B02552V BELGIUM BLACK	KB.USB03.080
	KEYBOARD USB 105KEY CHICONY KU-07606IC2552V ICELANDIC	KB.USB03.081
	KEYBOARD USB 105KEY CHICONY KU-07606N02552V NORWEGIAN BLACK	KB.USB03.082
	KEYBOARD USB 104KEY CHICONY KU-07603HB2552V HEBREW BLACK	KB.USB03.083
	KEYBOARD USB 105KEY CHICONY KU-07606PL2552V POLISH BLACK	KB.USB03.084
	KEYBOARD USB 105KEY CHICONY KU-07606YU2552V SLOVENIAN BLACK	KB.USB03.085
	KEYBOARD USB 105KEY CHICONY KU-07606CL2552V SLOVAK BLACK	KB.USB03.086
	KEYBOARD USB 104KEY CHICONY KU-07603S32552V RUSSIAN BLACK	KB.USB03.087
	KEYBOARD USB 105KEY CHICONY KU-07606HU2552V HUNGARIANBLACK	KB.USB03.088
	KEYBOARD USB 104KEY CHICONY KU-07603GR2552V GREEK BLACK	KB.USB03.089
	KEYBOARD USB 105KEY CHICONY KU-07606DK2552V DANISH BLACK	KB.USB03.090
	KEYBOARD USB 104KEY CHICONY KU-07603C02552V CZECH BLACK	KB.USB03.091
	KEYBOARD USB 105KEY CHICONY KU-07606R02552V ROMANIAN BLACK	KB.USB03.092
	KEYBOARD USB 105KEY CHICONY KU-07606TF2552V TURKISH BLACK	KB.USB03.093
	KEYBOARD USB 105KEY CHICONY KU-07606LA2552V SPANISH TUALATIN INTEL	KB.USB03.094
	KEYBOARD USB 105KEY CHICONY KU-07606TQ2552V TURKISH-Q BLACK	KB.USB03.095
	KEYBOARD USB 104 KEY LITE-ON SK-9625 SG-30700-XUW BLACK US VISTA	KB.USB0B.043
	KEYBOARD USB 104 KEY LITE-ON SK-9625 SG-30700-XMW BLACK TRADITIONAL CHINESE VISTA	KB.USB0B.044
	KEYBOARD USB 104 KEY LITE-ON SK-9625 SG-30700-XLW BLACK SIMPLIFIED CHINESE VISTA	KB.USB0B.045
	KEYBOARD USB 104 KEY LITE-ON SK-9625 BLACK US INTERNATIONAL	KB.USB0B.046
	KEYBOARD USB 104 KEY LITE-ON SK-9625 SG-30700-X1W BLACK ARABIC/ENGLISH VISTA	KB.USB0B.047
	KEYBOARD USB 104 KEY LITE-ON SK-9625 SG-30700-33W BLACK THAILAND VISTA	KB.USB0B.048
	KEYBOARD USB 105KS LITE-ON SK-9625 BLACK SPANISH	KB.USB0B.049
	KEYBOARD USB 105 KEY LITE-ON SK-9625 SG-30700-2PW BLACK PORTUGUESE VISTA	KB.USB0B.050
	KEYBOARD USB 105 KEY LITE-ON SK-9625 SG-30700-23W BLACK CANADIAN FRENCH VISTA	KB.USB0B.051
	KEYBOARD USB 107 KEY LITE-ON SK-9625 SG-30700-40W BLACK BRAZILIAN PORTUGUESE VISTA	KB.USB0B.052
	KEYBOARD USB 109 KEY LITE-ON SK-9625 SG-30700-2VW BLACK JAPANESE VISTA	KB.USB0B.053
	KEYBOARD USB 105KS LITE-ON SK-9625 BLACK GERMAN	KB.USB0B.054
	KEYBOARD USB 105KS LITE-ON SK-9625 BLACK ITALIAN	KB.USB0B.055
	KEYBOARD USB 105KS LITE-ON SK-9625 BLACK FRENCH	KB.USB0B.056
	KEYBOARD USB 105KS LITE-ON SK-9625 BLACK SWEDISH	KB.USB0B.057
	KEYBOARD USB 105KS LITE-ON SK-9625 BLACK UK	KB.USB0B.058
	KEYBOARD USB 105 KEY LITE-ON SK-9625 SG-30700-2HW BLACK DUTCH VISTA	KB.USB0B.059
	KEYBOARD USB 105KS LITE-ON SK-9625 BLACK SWISS/G	KB.USB0B.060

Category	Part Name	Acer Part Number
	KEYBOARD USB 105KS LITE-ON SK-9625 BLACK BELGIUM	KB.USB0B.061
	KEYBOARD USB 105 KEY LITE-ON SK-9625 SG-30700-2WW BLACK ICELANDIC VISTA	KB.USB0B.062
	KEYBOARD USB 105KS LITE-ON SK-9625 BLACK NORWEGIAN	KB.USB0B.063
	KEYBOARD USB 104 KEY LITE-ON SK-9625 SG-30700-XTW BLACK HEBREW VISTA	KB.USB0B.064
	KEYBOARD USB 105 KEY LITE-ON SK-9625 SG-30700-25W BLACK POLISH VISTA	KB.USB0B.065
	KEYBOARD USB 105 KEY LITE-ON SK-9625 SG-30700-2YW BLACK SLOVENIAN VISTA	KB.USB0B.066
	KEYBOARD USB 105 KEY LITE-ON SK-9625 SG-30700-24W BLACK SLOVAK VISTA	KB.USB0B.067
	KEYBOARD USB 104KS LITE-ON SK-9625 BLACK RUSSIAN	KB.USB0B.068
	KEYBOARD USB 105 KEY LITE-ON SK-9625 SG-30700-2GW BLACK HUNGARIAN VISTA	KB.USB0B.069
	KEYBOARD USB 104 KEY LITE-ON SK-9625 SG-30700-X2W BLACK GREEK VISTA	KB.USB0B.070
	KEYBOARD USB 105KS LITE-ON SK-9625 BLACK DANISH	KB.USB0B.071
	KEYBOARD USB 104 KEY LITE-ON SK-9625 SG-30700-XCW BLACK CZECH VISTA	KB.USB0B.072
	KEYBOARD USB 105 KEY LITE-ON SK-9625 SG-30700-52W BLACK ROMANIAN VISTA	KB.USB0B.073
	KEYBOARD USB 105 KEY LITE-ON SK-9625 SG-30700-41W BLACK TURKISH VISTA	KB.USB0B.074
	KEYBOARD USB 105 KEY LITE-ON SK-9625 SG-30700-29W BLACK SPANISH VISTA	KB.USB0B.075
	KEYBOARD USB 105 KEY LITE-ON SK-9625 SG-30700-28W BLACK TURKISH-Q VISTA	KB.USB0B.076
	KEYBOARD USB 105 KEY LITE-ON SK-9625 SG-30700-38W BLACK ARABIC/FRENCH VISTA	KB.USB0B.077
MAINBOARD		
	MAINBOARD DIG43L/AGREYHOUND W/RTC BATTERY	MB.SC101.001
MEMORY		
	MEMORY NANYA DDR3 1333MHZ 1G NT1GC64B88A0NF-CG	KN.1GB03.032
	MEMORY UNIFOSA DDR3 1333MHZ 1G UNB GU502203EP0200	KN.1GB0B.022
	MEMORY SAMSUNG DDR3 1333MHZ 1G M378B2873DZ1-CH9	KN.1GB0H.012
	MEMORY SAMSUNG DDR3 1333MHZ 1G M378B2873EH1-CH9	KN.1GB0B.024
	MEMORY MICRON DDR3 1333MHZ 1G M378B2873EH1-CH9	KN.1GB0B.030
	MEMORY HYNIX DDR3 1333MHZ 1G HMT112U6BFR8C-H9	KN.1GB0G.024
	MEMORY SAMSUNG DDR3 1066MHZ 1G UNB M378B2873DZ1-CF8	KN.1GB04.012
	MEMORY SAMSUNG DDR3 1333MHZ 2G M378B5673DZ1-CH9	KN.2GB0B.007
	MEMORY UNIFOSA DDR3 1333MHZ 2G UNB GU512303EP0200	KN.2GB0B.008
	MEMORY SAMSUNG DDR3 1333MHZ 2G M378B5673EH1-CH9	KN.2GB0H.006
	MEMORY MICRON DDR3 1333MHZ 2G MT16JTF25664AY-1G4D1	KN.2GB0B.014
	MEMORY SAMSUNG DDR3 1066MHZ 2G UNB M378B5673DZ1-CF8	KN.2GB04.009
	MEMORY NANYA DDR3 1333MHZ 2G NT2GC64B8HA0NF-CG	KN.2GB03.016
	MEMORY HYNIX DDR3 1333MHZ 2G HMT125U6BFR8C-H9	KN.2GB0G.015

Category	Part Name	Acer Part Number
POINTING DEVICE		
	MOUSE PS2 OPT SM-9620 LITEON SM-30600-00W	MS.11200.017
	LOGITECH 0810_PS2 OPTICAL MOUSE PS2 M-SBR-ACR2	MS.11200.013
	MOUSE USB OPT SM-9625 LITEON SM-30700-00W	MS.11200.018
	LOGITECH 0810_USB OPTICAL MOUSE USB M-UAY-ACR2	MS.11200.014
	MOUSE MG-0766T-657 CHICONY RF2.4G	MS.11200.015
POWER SUPPLY		
	POWER SUPPLY 220W NON-PFC 115V/230V LITEON PS-5221-06A1-ROHS	PY.2200B.001
	POWER SUPPLY 220W PFC 230V LITEON PE-5221-08AP-ROHS	PY.2200B.002
	POWER SUPPLY 220W 115VAC/230V DELTA NON-PFC DPS-220UB A	PY.22009.002
	POWER SUPPLY 220W PFC 230V DELTA DPS-220UB-1 A	PY.22009.003
	POWER SUPPLY 220W DELTA DPS-220UB	PY.22009.005
	POWER SUPPLY 220W LITE-ON DPS-220UB	PY.2200B.003
SCREWS		
	SCRW I NO6-32 L5 BZN	86.00J07.B60
	SCRW PAN #6-32 L6 NI BOXER WZS	86.00J44.C60
	SCERW #6-32 L5 PAN NI	86.00J90.B60
	SCREW PAN M3 L5 BZN	86.1A324.5R0
	SCREW FLAT #6-32*3/16 NI	86.5A5B6.012
SPEAKER		
	SPEAKER CHIAMAW 9M-20A200-000 ACER LOGO LF 0810	SP.10600.011
	SPEAKER JAZZ USB2.0 USB MS1238UA	SP.10600.013

Technical Specifications

This section provides technical specifications for the system.

Processor

Intel Core 2 Quad

Item	Specification						
Model number	Q6600	Q8200	Q8300	Q9300	Q9400	Q9550	Q9650
Core (nm)	65	45	45	45	45	45	45
L2 cache size (MB)	8	4	4	6	6	12	12
Clock speed (GHz)	2.4	2.33	2.5	2.5	2.66	2.83	3.0
Front side bus (MHz)	1066	1333	1333	1333	1333	1333	1333
Frequency (MHz)	2400	2333	2500	2500	2667	2833	3000
Socket	LGA 775	LGA 775	LGA 775	LGA 775	LGA 775	LGA 775	LGA 775
Clock multiplier	9x	7x	7.5x	7.5x	8x	8.5x	9x
Voltage (V)	1.1-1.372	0.85-1.3625	0.85-1.3625	0.85-1.3625	0.85-1.3625	0.85-1.3625	0.85-1.3625
Thermal design power (W)	95/105	95	95	95	95	95	95

Intel Core 2 Duo

Item	Specification			
Model number	E7400	E7500	E8500	E8600
Core (nm)	45	45	45	45
L2 cache size (MB)	3	3	6	6
Clock speed (GHz)	2.8	2.93	3.16	3.33
Front side bus (MHz)	1066	1066	1333	1333
Frequency (MHz)	2800	2933	3166	3333
Socket	LGA 775	LGA 775	LGA 775	LGA 775
Clock multiplier	10.5x	11x	9.5x	10x
Voltage (V)	0.85-1.3625	0.85-1.3625	0.85-1.3625	0.85-1.3625
Thermal design power (W)	65	65	65	65

Intel Pentium Dual-Core

Item	Specification			
Model number	E2220	E5200	E5300	E5400
Architecture (nm)	65	45	45	45
L2 cache size (MB)	1	2	2	2
Clock speed (GHz)	2.4	2.5	2.6	2.7
Front side bus (MHz)	800	800	800	800
Frequency (MHz)	2400	2500	2600	2700
Socket	LGA 775	LGA 775	LGA 775	LGA 775
Clock multiplier	12x	12.5x	13x	12.5x
Voltage (V)	0.85-1.5	0.85-1.3625	0.85-1.3625	0.85-1.3625
Thermal design power (W)	65	65	65	65

Intel Celeron Dual-Core

Item	Specification	
Model number	E1400	E1500
Architecture (nm)	65	65
L2 cache size (KB)	512	512
Clock speed (GHz)	2.0	2.2
Front side bus (MHz)	800	800
Frequency (MHz)	2000	2200
Socket	LGA 775	LGA 775
Clock multiplier	10x	11x
Voltage (V)	1.162-1.312	1.162-1.312
Thermal design power (W)	65	65

System Board Major Chips

Item	Specification
System core logic	Intel G43/G45 Express chipset + Intel ICH10 chipset
Memory controller	Intel G43/G45 Express chipset
Storage controller	Intel ICH10 chipset
Video controller	Intel G43/G45 Express chipset
PCIE controller	Intel G43/G45 Express chipset + Intel ICH10 chipset
LAN controller	Intel ICH10 chipset + Intel WG82567V Gigabit NIC
Audio controller	Realtek ALC888S 8-channel audio CODEC

System Memory

Item	Specification		
Memory controller	Intel G43/G45 Express chipset		
Memory type	DDR3-1066/1333 unbuffered DIMM		
Module name	PC3-8500/10600		
Organization	ECC		
DIMM sockets	Four		
Minimum memory	1 GB		
Maximum memory	2 GB		
Vendor	Micron	Samsung	Unifosa
Model name	DDR3-1333: - MT8JTF12864AY-1G4D1 - MT16JTF25664AY-1G4D1	DDR3-1066: - M378B2873DZ1-CF8 - M378B5673DZ1-CF8 DDR3-1333: - M378B2873DZ1-CH9 - M378B2873EH1-CH9 - M378B5673DZ1-CH9 - M378B5673EH1-CH9	DDR3-1333: - GU502203EP0200 - GU512303EP0200
DIMM size (GB)	1, 2	1, 2	1, 2
Pin	240	240	240
Memory clock (MHz)	DDR3-1066: 133 DDR3-1333: 166	DDR3-1066: 133 DDR3-1333: 166	DDR3-1066: 133 DDR3-1333: 166
I/O bus clock (MHz)	DDR3-1066: 533 DDR3-1333: 667	DDR3-1066: 533 DDR3-1333: 667	DDR3-1066: 533 DDR3-1333: 667

System BIOS

Item	Specification
BIOS vendor	American Megatrends Inc.
BIOS version	P01-A0
SPI Flash ROM	16 MB

Hard Disk Drive

Item	Specification		
Storage controller	NVIDIA NForce MCP73PV 1048 BGA		
Vendor	WD	Seagate	HGST
Model no.	WD1600AAJS-22L7A0 WD3200AAJS-22L7A0 WD6400AAKS-22A7B2 WD10EAVS-00D7B1	ST3160815AS ST3320813AS ST3640623AS	HDT721016SLA380 HDT721032SLA380 HDT721064SLA360
Interface	SATA II	SATA II	SATA II
Size	3.5-inch	3.5-inch	3.5-inch
Transfer rate (Gb/s)	3	3	3
Spindle speed (RPM)	7200	7200	7200
Capacity (GB)	160, 320, 640, 1000	160, 320, 640	160, 320, 640
Cache (MB)	160/320/1000 GB: 8 640 GB: 16	160/320 GB: 8 340 GB: 16	160/320 GB: 8 640 GB: 16

VGA Interface

Item	Specification
VGA controller	Intel G43/G45 Express chipset
Connector	VGA/monitor port

PCI Interface

Item	Specification
PCI controller	Intel G43/G45 Express chipset + Intel ICH10 chipset
Number of slots	PCI Express x 1 slot PCI Express x16 slot

Network Interface

Item	Specification
LAN controller	Intel ICH10 chipset + Intel WG82567V Gigabit NIC
Supports LAN protocol	10/100/1000 Mbps
LAN connector type	RJ45

SATA Interface

Item	Specification
SATA controller	Embedded SATA controller
Connectors	Two onboard SATA ports and one eSATA port

Audio Interface

Item	Specification
Audio controller	Realtek ALC888S 8-channel audio CODEC
Connectors	Audio 7.1 channel

Keyboard and Input Devices

Item	Specification
Controller	Intel ICH10 chipset + SIO IT8720
Connectors	<ul style="list-style-type: none"> • PS2 keyboard and mouse connector • Nine USB ports (five on front and four on rear)

Optical Drive

Super Multi

Item	Specification		
Vendor	HLDS	PLDS	Sony
Model name	GH-40F	DH-16A6S	AD-7203S
Drive type	Super Multi	Super Multi	Super Multi
Write Speed	DVD-R2x, 4x, 6x CLV, 8x ZCLV, 8x, 12x PCAV, 16x CAV DVD-R DL 2x, 4x, 6x CLV, 8x ZCLV DVD-RW1x, 2x, 4x, 6x CLV DVD-RAM 2x, 3x ZCLV, 3x-5x PCAV (Ver.2.2), DVD+R2.4x, 4x, 6x CLV, 8x, 12x ZCLV, 8x, 12x PCAV, 16xCAV DVD+R DL2.4x, 4x , 6x CLV, 8xZCLV DVD+RW2.4x, 4x, 6x CLV, 8xZCLV (High Speed DVD+RW: 6x CLV, 8x ZCLV) CD-R4x, 8x, 16x CLV, 24x, 32x, 40x PCAV CD-RW 4x, 10x, 16x CLV, 24x, 32x ZCLV (High Speed: 10x, Ultra Speed: 16x, 24x, US Plus: 16x, 24x, 32x)	DVD±R 4X, 6X CLV, 8X, 12X, 16X CAV DVD±RW 2X, 2.4X, 4X 6X CLV, 6X, 8X CAV DVD±R9 DL2x CLV, 4X, 6X CAV CD-RW 4X, 10X, 16X CLV, 8X, 16X CLV 24X, 32X, 40X, 48X CAV	DVD-R: 20x max. DVD +R: 20x max. DVD-RW: 6x max. DVD +RW: 8x max. DVD-R DL: 12x max. DVD +R9: 8x max. DVD-RAM: 12x max. CD-R: 48x max. CD-RW: 32x max.

Super Multi

Item	Specification		
Read Speed	DVD-R/RW/ROM(SL/DL) 10x / 8x / 16x / 12x max. DVD-R DL8x max. DVD-RAM (Ver.1.0/2.2) 2x/ 3x-5x P-CAV DVD+R/ +RW10x/8x max. DVD+R DL 8x max. CD-R/RW/ROM 40x / 40x / 40x max. CD-DA (DAE) 40x max. 80 mm CD 10x max.	CD-ROM / Finalized CD-R Data /CD-DAE /Video CD 4x / 8x CLV, 4x~10x / 6.5x~16x / 10x~24x / 13x~32x / 16x~40x / 20x~48x CAV Finalized CD-RW 4x / 8x CLV, 4x~10x / 6.5x~16x / 10x~24x / 13x~32x / 16x~40x / 20x~48x CAV Unfinalized CD-R/ RW 8X CLV DVD-ROM (single layer) 1.6x~4x / 2.4x~6x / 3.2x~8x / 4.8x~12x / 6.4x~16x CAV DVD-ROM (dual layer) 1.6x~4x / 2.4x~6x / 3.2x~8x / 4.8x~12x CAV DVD+R 2.4x / 4x CLV, 2.4x~6x / 3.2x~8x / 4.8x~12x / 6.4x~16x CAV DVD-R 2x / 4x CLV, 3.2x~8x / 4.8x~12x / 6.4x~16x CAV DVD+RW 2.4x / 4x CLV, 2.4x~6x / 3.2x~8x / 4.8x~12x CAV DVD-RW 2.4x / 4x CLV, 2.4x~6x / 3.2x~8x / 4.8x~12x CAV DVD+R9 2.4x / 4x CLV, 2.4x~6x / 3.2x~8x / 4.8x~12x CAV DVD-R9 2.4x / 4x CLV, 2.4x~6x / 3.2x~8x / 4.8x~12x CAV DVD-RAM 2x / 3x / 5x / 6x CLV, 8x / 12x CAV	DVD: 16x max. CD: 48x max.
Data Transfer Rate	—	—	—
Access Time	DVD: 145 ms CD: 125 ms	DVD: 160 ms CD: 140 ms	DVD: 160 ms CD: 140 ms
Buffer Size	4 MB	4 MB	2 MB
Interface Type	Serial ATA	Serial ATA	Serial ATA

DVD-ROM

Item	Specification	
Vendor	HLDS	PLDS
Model name	DH10N	DH-16D4S
Drive type	DVD-ROM	DVD-ROM
Write Speed	—	—
Read Speed	CD-ROM Max 52x DVD-ROM Max 16x	DVD-ROM (single layer) 2x CLV, 4X, 6X, 8X, 10X, 12X, 16X CAV DVD-ROM (dual layer) 2x CLV, 4X, 6X, 8X CAV DVD±R 2x CLV, 4X, 6X, 8X CAV DVD±RW 2x CLV, 4X, 6X, 8X CAV DVD±R DL2x CLV, 4X, 6X CAV CD-ROM, CD-R 4X, 8X CLV, 16X, 24X, 32X, 40X, 48X CAV CD-DAE4X, 8X CLV, 16X, 24X, 32X, 40X, 48X CAV CD-RW 4X, 8X CLV, 16X, 24X, 32X, 40X CAV DVD-RAM 2x CLV, 5X CAV
Data Transfer Rate	DVD-ROM Single Layered 22.1 Mbytes/s max. DVD-ROM Dual Layered 16.6 Mbytes/s max. DVD-ROM Video 11.1 Mbytes/s max. DVD-R/+R/+R Double 11.1 Mbytes/s max. DVD-RW/+RW 11.1 Mbytes/s max. DVD-RAM 4.7GB 6.93 Mbytes/s max. CD-ROM Mode1 7.2 Mbytes/s max. (CLV=1.2m/s disc) CD-R(Mode1) 7.2 Mbytes/s max. (CLV=1.2m/s disc) CD-RW(Mode1) 6.0 Mbytes/s max. CD-DA (D.A.E.) 7.2 Mbytes/s max.	DVD-ROM outside (20956 KB/sec) DVD-ROM inside (8100 KB/sec) DVD 9 Disc Outside (10200 KB/sec) DVD 9 Disc Inside (4050KB/sec) DVD+R/-R DL Disc Outside (7400 KB/sec) DVD+R/-R DL Disc Inside (2700 KB/sec) CD-ROM outside (7200 KB/sec) CD-ROM inside (2850 KB/sec) DVD-RAM outside (7000 KB/sec) DVD-RAM inside (2335 KB/sec)
Access Time	DVD-ROM (Random) 95 ms DVD-ROM (Full Stroke) 160 ms CD-ROM (Random) 90 ms CD-ROM (Full Stroke) 140 ms	CD 120 ms DVD 140 ms DVD-RAM 200 ms
Buffer Size	256KB	198 KB
Interface Type	Serial ATA	Serial ATA

